

**kleine**

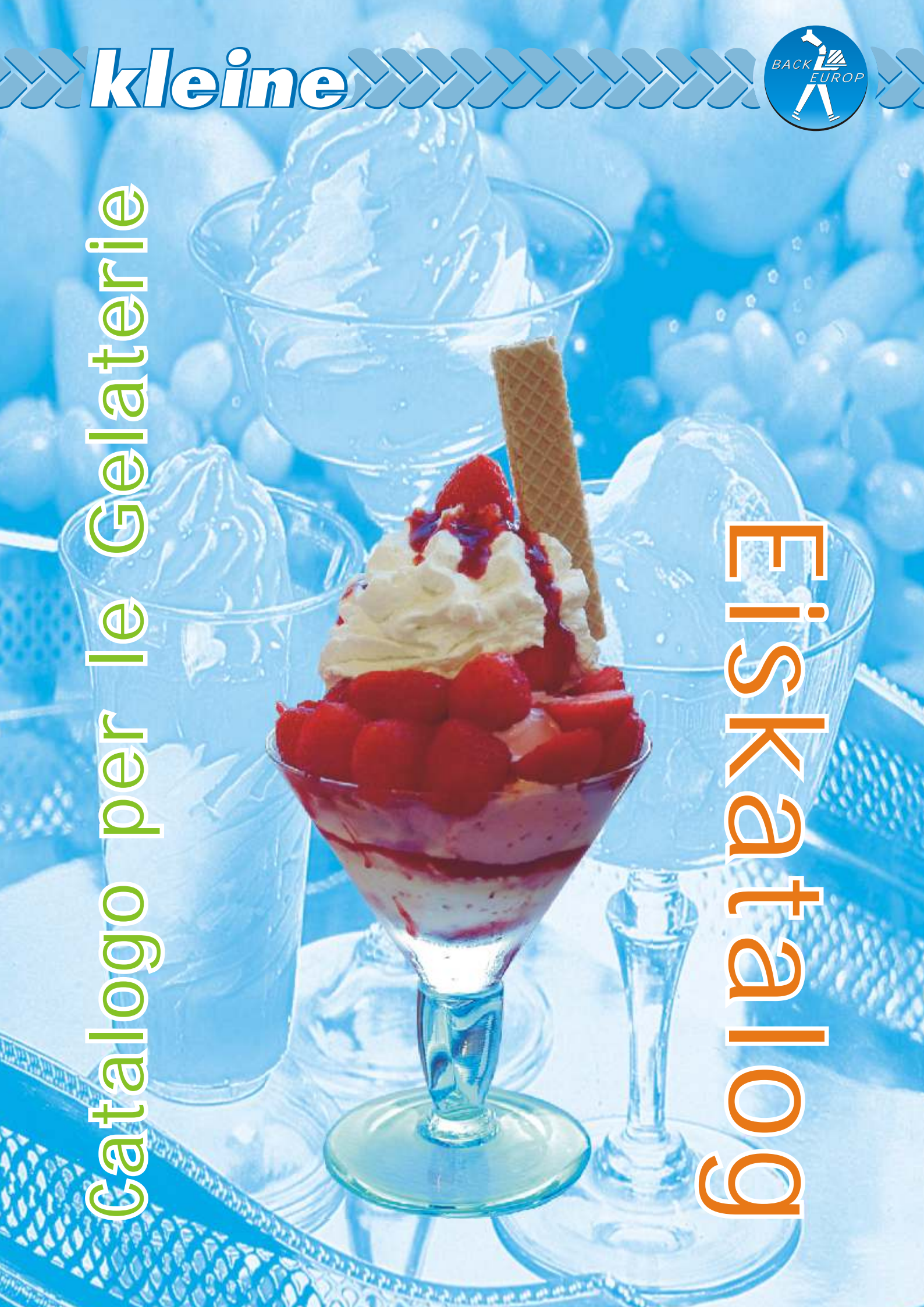

Catalogo per le Gelaterie

Eiskatalog





Seit über 100 Jahren stehen die Bedürfnisse unserer Kunden im Mittelpunkt unseres Denkens und Handelns.

Heute beliefern wir mehr als 800 Eisdielen, Cafés, Konditoreien und Bäckereien in Nordrhein-Westfalen und darüber hinaus.

Wir identifizieren uns voll und ganz mit unseren Kunden und sind auch auf zukünftige Veränderungen am Markt bestens vorbereitet.



Die Weichen für ein weiteres erfolgreiches Jahrhundert im Fachgroßhandel sind gestellt.

Eines aber wird sich auch in Zukunft für uns niemals ändern:

auf absolute Frische, höchste Qualität, top Service, prompte Lieferung, persönliche Beratung und faire Preise können Sie sich immer 100%-ig verlassen.

Wir sind für Sie da

Kleine GmbH & Co KG  
Langewanneweg 219  
59069 Hamm  
Tel: 0 23 81 / 5 80 80  
Fax: 0 23 81 / 5 35 42  
[www.kleine-hamm.de](http://www.kleine-hamm.de)  
[info@kleine-hamm.de](mailto:info@kleine-hamm.de)



## Joghurt und Quark

60482	Joghurt Natur	10 kg
60487	Joghurt Natur	5 kg
60901	Magerquark	10 kg
60902	Tuffi Magerquark	10 kg
60903	Magerquark	5 kg
61404	Kefir	10 kg
62055	Mascarpone 80%	500 g

## Milch

60010	Vollmilch frisch 3,5%	2x10 ltr
60025	Tuffi Vollmilch frisch 3,5%	10x1 ltr
60021	Tuffi Milch frisch 1,5%	10x1 ltr
60155	H-Milch 3,5%	10 ltr
60160	H-Milch 3,5%	5 ltr
60100	H-Milch 3,5%	12x1 ltr
60150	H-Milch 1,5%	12x1 ltr
29061	gezuckerte Vollmilch kond.	12,5 ltr
29062	gezuckerte Magermilch kon.	12,5 ltr
60304	Buttermilch	10x1 ltr



## Sahne

60809	Schlagsahne 33%	5 ltr
60806	Tuffi Schlagsahne 33%	5 ltr
60804	Schlagsahne 33% Eimer	5 ltr
60817	H-Schlagsahne 30%	12x1 ltr

## Butter und Butterfett

61210	Butter Block	10 kg
61234	Markenbutter 250g Gold	1 Stk
61179	Portionsbutter 200x10g	2 kg
61180	Portionsbutter 100x20g	2 kg
26354	Uniform Butterfett	10 kg



## Zucker

25852	Sandzucker	50 kg
25796	Sandzucker	25 kg
25851	Grundsorte fein	50 kg
25877	Grundsorte fein	25 kg
25873	Dextrose	25 kg
28146	Glukosepulver	25 kg
26148	Lactose	25 kg
25878	Maltodextrin	25 kg
25854	Puderzucker	10 kg
27746	Fruchtzucker	500 g
25862	Sahnesüß mit Standmittel	5 kg
25856	Raffinade flüssig	12,5 kg
25884	Glukose-Sirup 43%	12,5 kg
25883	Glukose-Sirup 45%	12,5 kg
29688	Puritose	300 kg



## Milchpulver

25690	Vollmilchpulver 26%	25 kg
26221	Magermilchpulver	25 kg
26222	Magermilchpulver instant	25 kg
26163	Buttermilchpulver	25 kg
26223	Sahnepulver 42%	25 kg
26162	Süßmolkepulver	25 kg



## Ei Produkte

25496	Eigelb flüssig	1 kg
25527	Eiweiß flüssig	1 kg
25509	*Crico Eigelb Granulat gefror.	10 x1 kg
25539	*Crico Eigelb Granulat gefror.	2x5 kg



### Obstkonserven

		Dosen/Karton
26237	Ananas Scheiben 580 g	6
26259	Ananas Scheiben Nr.10 1790 g	6
26929	Baby-Ananas Scheiben 5 cm	6
26239	Ananas Stücke Nr.10 1840 g	6
26245	Aprikosen halb 480 g	24
26244	Aprikosen halb 1500 g	6
26269	Aprikosen-Pulpe Alhambra 5/1	6
26243	Aprikosen Oreille 2500 g	6
26403	Erdbeeren Glas 900 ml	12
26317	Fruchtcocktail 480 g	24
26333	Fruchtcocktail 1500 g	6
28598	Heidelbeeren Glas 720 g	12
26319	Kaiserkirschen 480 g	12
29702	Mandarinen 480 g	24
26246	Mandarinen 1500 g	6
26308	Pfirsiche Scheiben 490 g	24
26877	Pfirsiche Scheiben 1540 g	6
26976	Pfirsiche halb 480 g	24
25682	Pfirsiche halb 1470 g	6
26268	Sauerkirschen USA 2000 g	6
03765	Schattenmorellen Glas 680 g	12
28929	Williams-Christ Birnen 480 g	24
26330	Williams-Christ Birnen 1500 g	6

### Zitro-Produkte / Säuren

01230	Zitronensaft 100% 750 ml	6 Fl.
29122	Zitronenschale gezuckert	2,5 kg
32949	Zitronenpulver 90 g	5 kg
33829	Fruchtsäure	6 ltr
33833	Fruchtsäure	1 ltr
33843	Fruchtsäure kristallisiert	1 kg
29719	Weinsäure	1 kg



## Tiko-Früchte

26258	*Ananasstücke	10 kg
26287	*Beerenteller	10 kg
26284	*Brombeeren	10 kg
26285	*Erdbeeren polnisch	10 kg
26294	*Erdbeeren	4x2,5 kg
26277	*Heidelbeeren	10 kg
26275	*Himbeeren	10 kg
26543	*Himbeergries	10 kg
26279	*Johannisbeeren rot	10 kg
26283	*Kiwischeiben	10 kg
26251	*Mangowürfel	10 kg
26224	*Melonenbällchen gelb	10 kg
26301	*Papayawürfel	10 kg
26225	*Pfirsichwürfel	10 kg
26290	*Rhabarber	10 kg
26273	*Sauerkirschen	10 kg
26280	*Stachelbeeren	10 kg
26291	*Tropicana	10 kg

## Tiko-Fruchtpüree

33680	*Ananas-Püree	6x1 kg
33648	*Aprikosen-Püree	6x1 kg
33682	*Apfel-Püree	6x1 kg
33683	*Bananen-Püree	6x1 kg
33699	*Cassis-Püree	6x1 kg
33684	*Erdbeer-Püree	6x1 kg
33743	*Heidelbeer-Püree	6x1 kg
33685	*Himbeer-Püree	6x1 kg
33649	*Maracuja-Püree	6x1 kg
33687	*Mango-Püree	6x1 kg
33688	*Melonen-Püree	6x1 kg
33692	*Papaja-Püree	6x1 kg
33693	*Pfirsich-Püree	6x1 kg
33745	*Sauerkirsch-Püree	6x1 kg
33694	*Tropical-Püree	6x1 kg



## Tiko-Fruchtsaft (Gatto)

33686	*Limetten-Saft	12x500 g
33836	*Mandarinen-Saft	24x500 g
33689	*Orangen-Saft	24x500 g
33690	*Zitronen-Saft	24x500 g

## Frisches Obst

66215	Ananas	Stk
66060	Bananen	Kg
66211	Birnen	Kg
66021	Brombeeren	Sch
66331	Carambola	Stk
66143	Clementinen	Btl
66050	Erdbeeren	Sch
66051	Erdbeeren halb, geputzt	Sch
66243	Feigen	Stk
66142	Grapefruit	Stk
66164	Heidelbeeren	Sch
66165	Himbeeren	Sch
66111	Honigmelone	Stk
66150	Johannisbeeren rot	Sch
66346	Kirschen	Kg
66090	Kiwi	Stk
66091	Kiwischeiben	Sch
66124	Kokosnuss	Stk
66152	Limetten	Stk
66155	Mango	Stk
66140	Orangen	Stk
66183	Papaya	Stk
66303	Pfirsiche	Stk
66074	Physalis	Sch
66347	Waldbeeren	Sch
66110	Wassermelone	Stk
66030	Zitrone	Stk

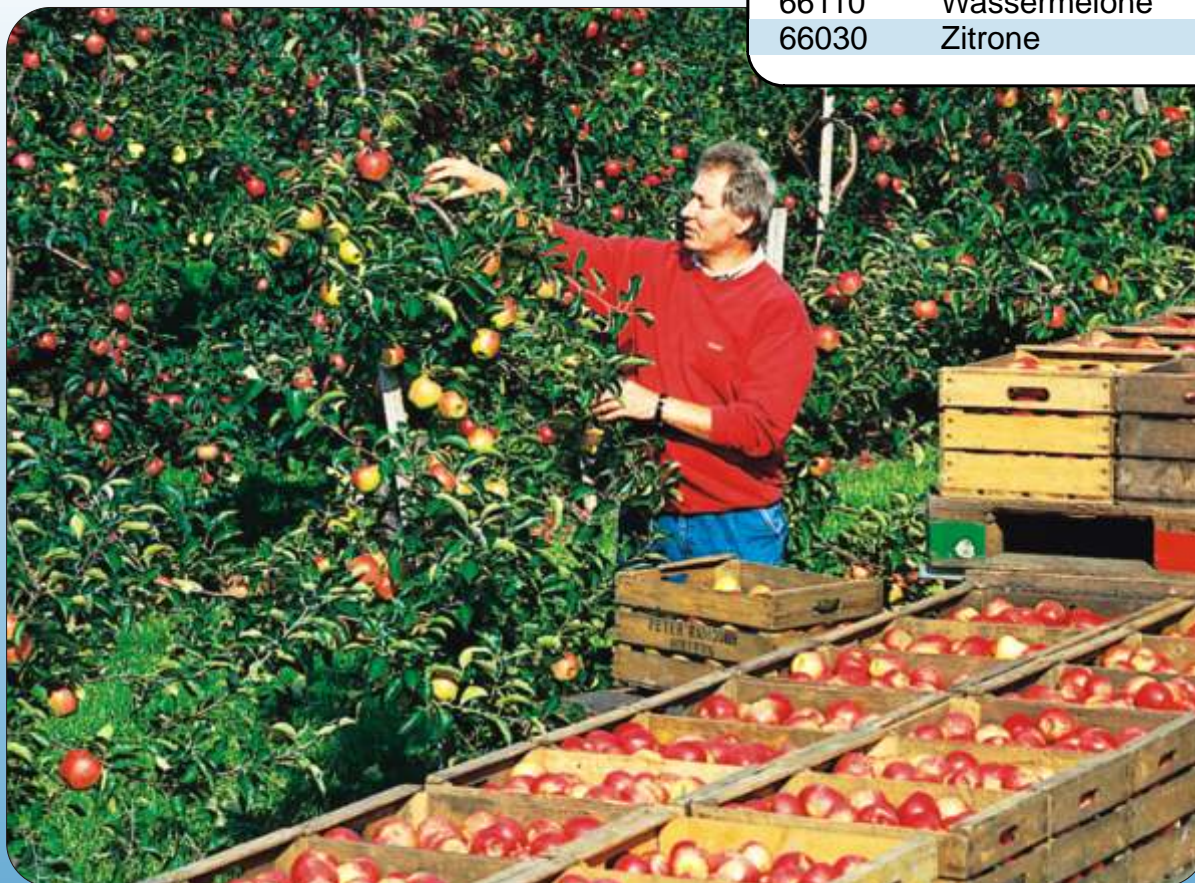

## Kakaopulver / Kuvertüre

27328	Kakao De Zaan 20-22%	1 kg
27327	Kakao De Zaan 20-22%	5 kg
27319	Dutch Kakao 22-24%	5 kg
32161	Pernigotti Kakao 20-22%	12x1 kg
29098	Kuvertüre weiß	2,5 kg
27340	Kuvertüre Vollmilch	2,5 kg
27339	Kuvertüre zartbitter 38%	2,5 kg
32197	Schokofix Trinkschokolade	2 kg



## Nüsse

28854	Haselnüsse gehackt geröstet	12,5 kg
26866	Haselnüsse gehobelt	12,5 kg
28594	Haselnussgrieß	12,5 kg
26991	Mandeln braun	12,5 kg
26821	Mandeln weiß	12,5 kg
26989	Mandeln gehobelt	12,5 kg
28673	Mandeln gehackt	12,5 kg
28449	Mandeln gestiftet	12,5 kg
27432	Pistazien enthäutet	0,5 kg
26943	Walnusskerne Bruch	5 kg
26941	Walnusskerne franz. Cerneaux	1,8 kg

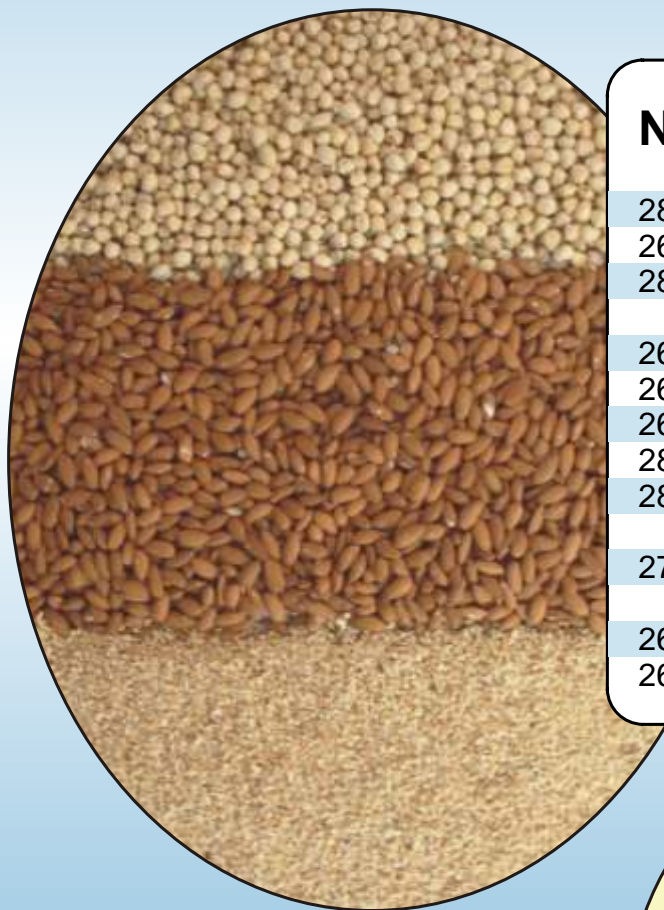

## Trockenfrüchte

26783	Aprikosen geschwefelt	12,5 kg
26707	Kokosraspel fein	5 kg
26702	Kokosraspel mittel	5 kg
26784	Pflaumen entsteint m.Sorbat	10 kg
26729	Rosinen Australien	14 kg
26788	Rosinen Süd-Afrika	13 kg



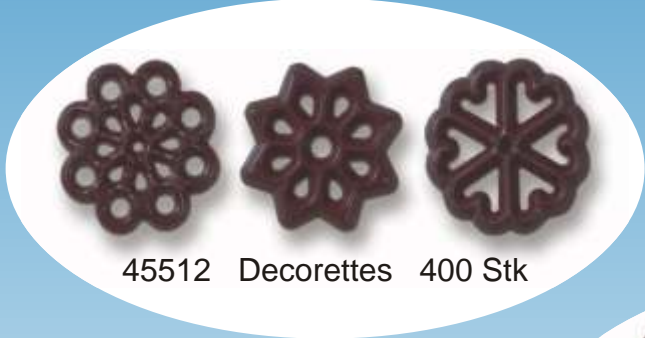

45512 Decorettes 400 Stk



45513 Decorettes Exclusiv 310 Stk



45514 Diabolo Viereck 465 Stk



45515 Diabolo Dreieck 290 Stk



45516 Diabolo Rechteck 375 Stk



45517 Schokolocken groß 330 Stk



45518 Schoko-Gitter 380 Stk

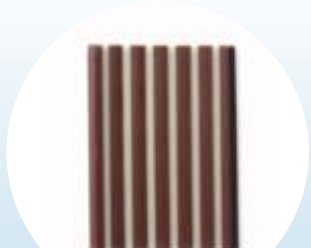

45519 Domino 340 Stk



45501 Schoko-Röllchen klein 3150 Stk



45502 Schoko-Röllchen groß 1000 Stk



45503 Mini-Fächer 500 Stk



45506 Cigarillos 14 cm Retro Weiß 200 Stk

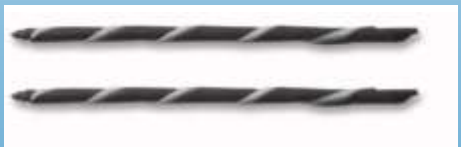

45510 Cigarillos 14 cm Dunkel / Weiß 200 Stk



45511 Cigarillos 14 cm Retro Milch 200 Stk



### Schokodekor

27268	Hewiko Raspelschokolade	2,5 kg
27367	Hewiko Raspelschokolade weiß	2,5 kg
31983	Kondima Raspelschokolade fein	5 kg
31982	Kondima Raspelschokolade grob	5 kg
31981	Kondima Raspelschokolade weiß	5 kg
31985	Ulmer Raspelschokolade	2,5 kg
27257	Schokostreusel	2,5 kg
27259	Schokoplättchen	2,5 kg
27286	Mokkabohnen Vollmilch	1 kg
27287	Mokkabohnen zartbitter	1 kg

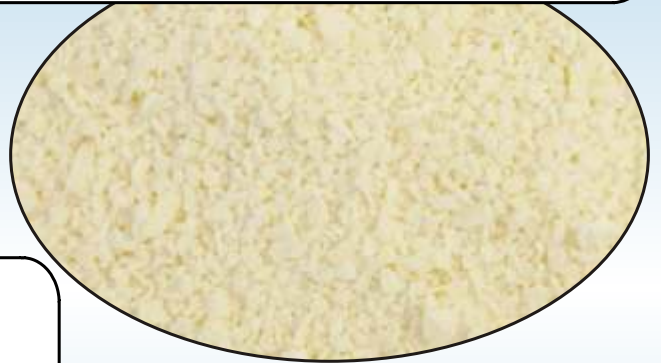

### Nussdekor

31740	Sucrest Haselnussstücke karamel.	1 kg
28227	Sucrest Walnussstücke karamel.	1 kg
31739	Sucrest Sahne-Karamelstücke	1 kg
28212	Sucrest Nusskrokant Streusel	2,5 kg
28182	Sucrest Nusskrokant Streusel	5 kg
29679	Fugar Mandelkrokant ganz	2 kg



### Nussdekor St. Remor

34015	Haselnüsse geröstet ganz Cuneo	2 kg
34023	Haselnüsse geröstet gehackt Cun.	2 kg
34034	Haselnussstücke karamellisiert	2,5 kg
32074	Walnussstücke karamellisiert	0,5 kg
32704	Walnussstücke karamellisiert	1,5 kg

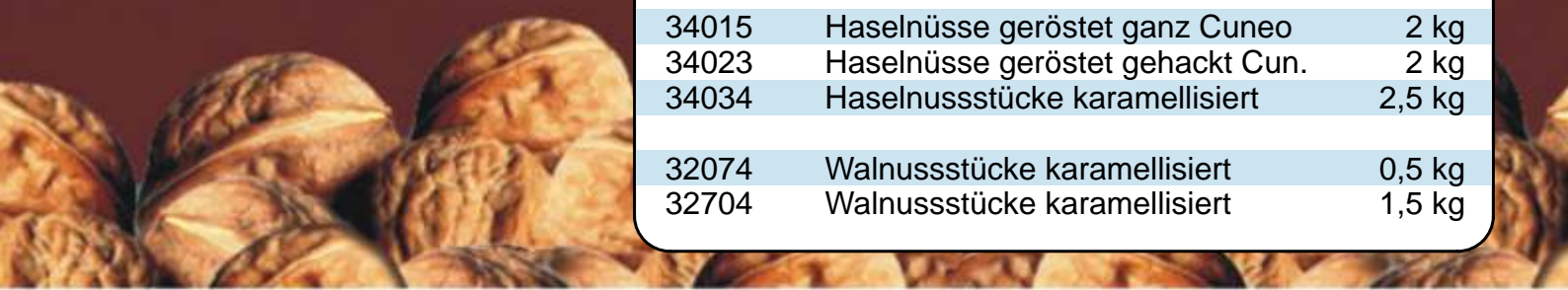



Toschi-Amarena		
31157	Toschi Amarena Kirschen 20-22	5,6 kg
34507	Toschi Amarena Variegato	3 kg
31098	Toschi Amarena Sirup	6,5 kg



Vanille-Stangen		
32941	Vanille Bourbon 20-22	1,4 kg
32019	Vanille Tahiti	1 kg



## Liköre

32065	GR-Brotto Alchermes 28%	1
30533	GR-Brotto Amaretto 24%	1
30621	GR-Brotto Cherry 28%	1
30623	GR-Brotto Chioccolato al Ovo	1
30625	GR-Brotto Curacao Blue	1
30530	GR-Brotto Curacao rot	1
30627	GR-Brotto Kofi	1
32160	GR-Brotto Kiwi	1
32062	GR-Brotto Limone	1
30632	GR-Brotto Mandarino	1
30628	GR-Brotto Maraschino	1
33154	GR-Brotto Menta grün	1
30531	GR-Brotto Nocciola	1
30525	GR-Brotto Noce	1
33156	GR-Brotto Ovo-Zabaione	1
33036	GR-Brotto Presca	1
32077	GR-Brotto Prugna	1
32080	GR-Brotto Punch al Arancio	1
32081	GR-Brotto Punch al Mandarino	1
32620	GR-Brotto Grappa Estero 40%	1
32072	GR-Brotto Grappa Prosecco 42%	1
32612	Filipetti Marsala All Uovo	1
32614	Filipetti Marsala All Uovo	2
34200	Strega Liquore	0,7
34008	Malaga-Wein Kanister	2,5
32985	Malaga-Wein Kanister	10



## Camel

33002	Camel Amaretto 16%	1
33017	Camel Apricot 28%	1
33018	Camel Su Tiramisu 16%	1

## Cocktail-Liköre

33423	Cinderella (ohne Alkohol)	0,7
33422	Primavera (ohne Alkohol)	0,7
33421	Sportivo (ohne Alkohol)	0,7
33426	Dolomiti 28%	0,7
33424	Rimini-Lover 28%	0,7
33427	Stromboli-Fire 40%	0,7
33425	Venezia 28%	0,7



## Spirituosen

15739	Aperol	0,7
17314	Amaretto Romanza 20%	0,7
17378	Bacardi Rum 37%	0,7
17006	Baileys 17%	0,7
17003	Batida de Coco 16%	0,7
15738	Campari bitter 25%	0,7
18385	Cointreau 40%	0,7
16620	Eierlikör Van Dolft 14%	0,7
18000	Eierlikör Verpoorten	0,7
17004	Fernet branca 42%	0,7
15710	Martini bianco	0,75
17404	Pott Rum 40%	0,7
16632	Ramazotti 30%	0,7
16637	Sambuca Molinari 40%	0,7
34200	Strega Liquore 40%	0,7
16736	Türk. Mocca	0,5
16634	Vecchia Romagna 38%	0,7
18115	Wodka Gorbatschow 40%	0,7



## Sprizzerol

15741	Sprizzerol 250 ml	24
-------	-------------------	----



## Wein und Prosecco

15971	Il Colle Cabernet Doc Piave	6x0,75
15969	Il Colle Pinot Grigio Doc Piave	12x0,75
15881	Il Colle Prosecco Doc Frizzante	6x0,75
15883	Il Colle Prosecco Piccolo	30x0,2
16007	Il Colle Prosecco Doc Spumante	6x0,75



## San Pellegrino

01182	San Pellegrino Mineralwasser 0,25	24
32090	San Bitter 0,10	54

## Pago 0,2 ltr

31025	Pago ACE	24
31035	Pago Ananas	24
31059	Pago Apfel	24
31026	Pago Banane	24
31027	Pago Birne	24
31028	Pago Erdbeer-Cocktail	24
31217	Pago Blutorange-Limette	24
31029	Pago schwarze Joh.beere	24
31045	Pago Mango	24
31031	Pago Multivitamin	24
31047	Pago Orange	24
31032	Pago Pfirsich	24
31218	Pago Pflaume	24
31033	Pago Sauerkirsch	24
31034	Pago Tomate	24





## Coca Cola

01104	Bonaga 0,33 ltr	24
01325	Bonaga 0,5 ltr	12
01209	Bonaga 1 ltr	12
01100	Coca Cola 0,33 ltr	24
01320	Coca Cola 0,5 ltr	12
01196	Coca Cola 1 ltr	12
01101	Coca Cola light 0,33 ltr	24
01321	Coca Cola light 0,5 ltr	12
01199	Coca Cola light 1 ltr	12
01333	Coca Cola Zero 0,5 ltr	12
01334	Coca Cola Zero 1 ltr	12
01102	Fanta Orange 0,33 ltr	24
01323	Fanta Orange 0,5 ltr	12
01202	Fanta Orange 1 ltr	12
01329	Lift Apfelschorle 0,5 ltr	12
01330	Lift Apfelschorle 1 ltr	12
01324	Mezzo Mix 0,5 ltr	12
01259	Mezzo Mix 1 ltr	12
01103	Sprite 0,33 ltr	24
01322	Sprite 0,5 ltr	12
01208	Sprite 1 ltr	12

## Ferrero

07522	Giotto Stange	15
07521	Küsschen 5 Stück	15
07507	Mon Cheri 5 Stück	15
07570	Raffaello 4 Stück	16
07503	Rocher 4 Stück	16
06959	Duplo	40
07511	Hanuta doppelt	18
07535	Kinder Bueno	30
07531	Kinder Country Riegel	40
07726	Kinder Schoko Bons	16
07519	Kinderschokolade 100g	10
07520	Yogurette 100 g	10



Motta  
International  
**Cocoa  
Club**



White Ciok



Brown Classic



Red Pepper



Amaretto



Latte Vollmilch



Nocciola Haselnuss

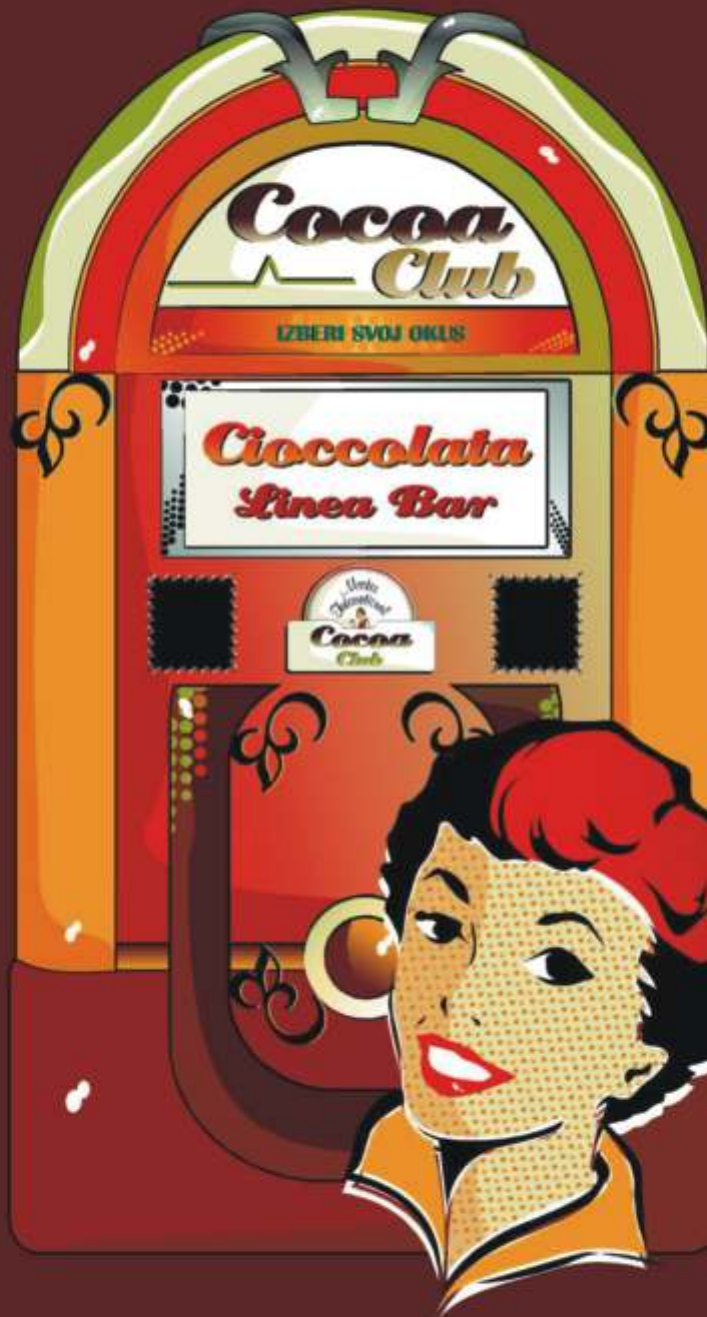

Gianduiotta Nougat



Cocobello



Bacio



Nero Fondente Dunkel



Cocco



Light Fettarm

*Laß Dich von einem  
Traum aus heißer  
Schokolade verwöhnen*





### Caffé Bristot

32075	Bristot Classico *	6 kg
32020	Bristot Cortina *	6 kg
32003	Bristot Tiziano *	6 kg
32023	Bristot Decafeinato Tabs	25 Stk



### Lavazza Kaffee

32029	Lavazza Gran Espresso *	6 kg
32586	Lavazza Oro *	6 kg
32028	Lavazza Super Crema *	6 kg



### Sonstige Kaffees

32008	Kaffee Espresso *	10 kg
32012	Golosso Viveri *	6 kg

### Pavan Caffé

32762	Pavan Caffé *	10 kg
-------	---------------	-------

\* versteuert nach § 8 KaffeeStG



**TIZIANO 1919**  
Bohnenware  
2x3000g



**TIZIANO**  
Qualità Superiore  
Bohnenware  
6x1000g



**ARABICA 100%**  
Bohnenware  
6x1000g



**SPECIALE**  
Bohnenware  
6x1000g



**CREMA ORO**  
Bohnenware  
6x1000g



**CORTINA**  
Bohnenware  
6x1000g



**BAR ESPRESSO**  
Bohnenware  
6x1000g



**CLASSICO**  
Bohnenware  
6x1000g



**DECAFFEINATO**  
Bohnenware  
6x1000g



**DECAFFEINATO**  
Spenderbox  
Neue Verpackung a 50x7g Tabs



**RAINFOREST**  
Bohnenware  
6x1000g



**ARABICA 100%**  
Gemahlen  
24x250g



**ESPRESSO**  
Tabs  
150x7g Tabs



**CLASSICO**  
Bohnenware  
10x500g



**ARABICA 100%**  
Gemahlen  
20x250g Beutel



**ORO**  
Gemahlen  
20x250g Beutel



**ESPRESSO**  
Gemahlen  
20x250g Beutel



**CLASSICO**  
Gemahlen  
20x250g Beutel



**DECAFFEINATO**  
Gemahlen  
20x250g Beutel

Generallimport für D: **OTTO FRANCK IMPORT KG**  
Statzfinger Str. 63 · D - 86165 AUGSBURG  
Tel. 0821 7940240/41 · Fax 0821 79402-49  
E-Mail: espresso@ottofrank.de · www.caffebristolot.com

cod. 99021

## Portionszucker

32014	Feinzucker Beutel Italia 4g	2000 Stk
32018	Feinzucker Beutel Streifen 4g	2000 Stk
32009	Sugar Babies Zuckersticks 4g	1000 Stk
32011	Bristol Zuckersticks	1000 Stk
10959	Süßstoff 2er	2000 Stk



## Beilage-Kekse

29715	La Cima	200 Stk
31058	Bistro-Box Mix	150 Stk
33651	Aladin Buttergebäck	150 Stk
31167	Caramellino	200 Stk

## Kaffeesahne

01432	BackEurop Kaffeesahne 10% 7,5g	240 Stk
01425	Kaffeesahne Kännchen 165g	20 Stk
01435	Kaffeesahne 10%	1 ltr

## Pulver

32902	Anselmi Cremante Pulver	1 kg
32022	MB Eurocreme Bindemittel	10 kg
32092	MB Protolat Base	10 kg



## Eispasten

32866	Anselmi Menta grün	3 kg
32867	Anselmi Pistazien fein	3 kg
32877	Anselmi Walnuss Sorrentina	3 kg
33178	MB Rumkrokant	3 kg

## Variegato / Dekor

32871	Anselmi Pfirsich-Orange Varieg.	1,5 kg
32842	Anselmi Graniglia Croccante	5 kg

# Bechtolina



## Bindemittel

32307	Bechtolina Neutral 152 A	1 kg
32308	Bechtolina Neutral 152 A	4 kg
32296	Bechtolina Neutral 152 D	1 kg
32295	Bechtolina Neutral 152 D	4 kg

## Aromen

31161	Bechtolina Rum à la Jamaika	1 kg
32973	Bechtolina Sahnearoma A Pulver	1 kg
32300	Bechtolina Vanille weiß 155 A	1 kg
33922	Bechtolina Vanille gelb 155 A	4 kg

# FABRI

1905

## Pulver

33419	Fabbi Coccobello	15 kg
33430	Fabbi Euromix FDL 100	20 kg
32627	Fabbi Fabbriyog	1 kg
32981	Fabbi Integratore	20 kg
33077	Fabbi Nevefrutta	20 kg
33078	Fabbi Nevepan 50 F	20 kg
33082	Fabbi Nevepan 100	16 kg
32629	Fabbi Schokopulver	20 kg
32628	Fabbi Superpanna Piu	20 kg
33634	Fabbi Superpanna CF	20 kg
32441	Fabbi Zitrone LG	1 kg
33821	Fabbi Zitrone L	6 kg

## Pasten

32634	Delipaste Ananas	1,5 kg
33286	Delipaste Aprikose	1,5 kg
33224	Delipaste Banane	1,5 kg
32990	Delipaste Ciocco Bianco	4,1 kg
32635	Delipaste Erdbeer	1,5 kg
32637	Delipaste Grüner Apfel	1,5 kg
32638	Delipaste Heidelbeere	1,5 kg
32642	Delipaste Himbeere	1,5 kg
33289	Delipaste Kiwi	1,5 kg
32648	Delipaste Menta	1,5 kg
32646	Delipaste Melone	1,5 kg
32643	Delipaste Pfirsich	1,5 kg
32649	Delipaste Walnuss A	4 kg
32654	Delipaste Vanille Super	1,5 kg
33628	Delipaste Zabajone	6 kg
32630	Pastogel Azzurocreme	1,35 kg
32625	Pastogel Tuttogel	1,35 kg
32391	Pastogel Vanille	1,35 kg
39092	Delipaste Lello	3,8 kg
33225	Pastovocreme	1,4 kg

## Variegati

33153	Amarena Variegato ohne Farbe	3,2 kg
32768	Amarena Variegato mit Farbe	3,2 kg
32778	Maracuja Variegato	3,2 kg
32776	Orange Variegato	3,2 kg

## Amarena

32640	Amarena Kirschen Tantofrutto	3,2 kg
32410	Amarena Sirup	3 kg

## Früchte in Alkohol

32833	Aprikosen in Alkohol	1,7 kg
32381	Baba in Alkohol	1,9 kg
32833	Fruttisieme in Alkohol	1,72 kg
32386	Kirschen in Alkohol	1,65 kg
32415	Pflaumen in Alkohol	1,8 kg
32590	Rosinen in Alkohol	1,8 kg

## Mixybar

39093	Mixybar Amarena	1,3 kg
33758	Mixybar Banane	1,3 kg
33763	Mixybar Erdbeer	1,3 kg
33772	Mixybar Orange	1,3 kg
32650	Mixybar Pfefferminz	1,3 kg
39095	Mixybar Tropical Blue	1,3 kg

## Kaffee-Sirup

33626	Fantasy Amaretto	740 g
33627	Fantasy Irish Cream	740 g
33633	Fantasy Karamel	740 g
33840	Fantasy Kokos	740 g
33639	Fantasy Schokolade	740 g
33646	Fantasy Vanille	740 g
33650	Fantasy Zimt	740 g

## Diverse

39091	Chiara Frutta	0,9 kg
33642	Stracciatella	10 kg

# Gelatop



## Eispasten Gelatop

32857	Apfel 261	5 kg
32874	Apfelsine 285	5 kg
32673	Banane 272	5 kg
32427	Buttermilch 563	5 kg
32430	Cremona 231	5 kg
33462	Caramella 412	5 kg
32396	Cookies 405	5 kg
32405	Delfino Blau 392	5 kg
32414	Drachenfrucht 266	5 kg
32680	Erdbeere 256	5 kg
32409	Haselnuss ohne Stk. 250	5 kg
33529	Haselnuss mit Stk. 249	5 kg
32679	Himbeere 258	5 kg
32407	Kirsch-Cola 393	5 kg
32439	Kokos 277	5 kg
32585	Malaga 245	5 kg
32440	Mango 283	5 kg
32677	Marzipan 257	5 kg
32389	Mascarpone 571	5 kg
32520	Miranda Erdnuss 235	5 kg
32944	Mocca 413	5 kg
32672	Panna Cotta 274	5 kg
33037	Pfirsich-Maracuja 276	5 kg
32504	Pistazien ohne Stk 414	5 kg
32507	Pistazien mit Stk 416	5 kg
32674	Pina Colada 238	5 kg
33656	Pflaume 279	5 kg
32774	Sahne 271	5 kg
32847	Schokolade 391	5 kg
33638	Schwarzwälder Kirsch 288	5 kg
32715	Vanille 263	5 kg
32720	Vanille Piu 287	5 kg
33088	Vanille Zoldo 428	5 kg
32678	Waldmeister 406	5 kg
32453	Walnuss 268	5 kg
31462	Wiener Mandel 254	5 kg

## Eispasten Europa

31949	Banane 465	5 kg
31049	Erdbeere 454	5 kg
31050	Gummibärchen 474	5 kg
33659	Limette-Cola 356	5 kg
31133	Orange-Cola 441	5 kg
31132	Zitrone-Cola 437	5 kg

## Pulver

33661	ACE Balance 361	7,2 kg
33632	Schokolade m. Bindung 539	5 kg
33746	Tricrema 100 515	15 kg
33226	Tridex 541	20 kg
31273	Trifrutta 100 544	20 kg
33747	Trilonga 35 504	5 kg
27502	Trimix Universal 527	5 kg
31466	Tripanna 545	5 kg
33641	Tripasto 50 522	20 kg
31164	Tripronto 100 516	20 kg
31144	Trirapido 50 572	20 kg
33186	Joghurt 538	5 kg
32597	Quarcotta 532	5 kg
32501	Limonette 543	5 kg

# Gelato



## Marmorata

31467	Caramel 554	3 kg
32398	Cookies 584	3 kg
33534	Erdbeer Fl. 534	1,2 kg
33274	Espresso 564	3 kg
31465	Gianduia 512	3 kg
33535	Holunder Fl. 558	1,2 kg
33536	Limette Fl. 552	1,2 kg
31471	Orange 556	6 kg
33537	Pfirsich-Marac.Fl.	1,2 kg
31956	Pfirsich-Maracuja	5 kg
32528	Sauerkirsch 553	5 kg



## Toppings

32803	Amarena-Flip 575	1 kg
32191	Amaretto-Flip 585	1 kg
32523	Bananen-Flip 588	1 kg
32516	Cherry-Flip 592	1 kg
32713	Choco-Mint-Flip 576	1 kg
32972	Creme-Caramel-Flip 562	1 kg
32522	Erdbeer-Flip 595	1 kg
32517	Haselnuss-Flip 599	1 kg
32518	Heidelbeer-Flip 593	1 kg
32527	Himbeer-Flip 594	1 kg
32526	Karamel-Flip 598	1 kg
32194	Kirschwasser-Flip 583	1 kg
32675	Kiwi-Flip 580	1 kg
32506	Kokos-Flip 590	1 kg
32508	Limoncello-Flip 573	1 kg
32502	Mango-Flip 589	1 kg
32711	Maracuja-Flip 578	1 kg
32524	Mohren-Flip 597	1 kg
32525	Mokka-Flip 596	1 kg
32805	Praliné-Flip 582	1 kg
33219	Tiramisu-Flip 560	1 kg
32519	Tropic-Flip 591	1 kg
32513	Vanille-Flip 587	1 kg
32532	Waldbeeren-Flip 567	1 kg
31051	Waldmeister-Flip 577	1 kg
32515	Walnuss-Flip 574	1 kg
32529	Zabajone-Flip 586	1 kg



## Saucen im Kanister

32937	Erdbeer-Sauce 331	10 kg
32938	Haselnuss-Sauce 334	10 kg
33228	Himbeer-Sauce 333	10 kg
32939	Schoko-Sauce 332	10 kg

# Gelato



## Kits

32717	Buttermilch-Kit	11 kg
32413	Drachenfrucht-Kit	10 kg
32408	Eierlikör-Kit	8 kg
32411	Florentiner-Kit	13 kg
32416	Marshmallow-Kit	10,4 kg



## Sonstige Zutaten

26097	Crema Volumina 524	5 kg
27649	Fruchtsäure flüssig 533	1 kg
31463	Gela Frutta 551	5 kg
32455	Stracciatella Mohr 526	5 kg
32543	Trialgin 531	1,5 kg
27470	Rum Supra 423	1 kg
27600	Sahne Aroma 713	1 kg
32376	Uva Varieta 458	1 kg



## Dekor

27674	Borkensplitter 528	5 kg
45418	Schokospäne dunkel 973	2 kg
45408	Schokospäne weiß 969	2 kg
45082	Aufleger Eierlikör 049	270 Stk
45349	Aufleger Joghurt 366	200 Stk
45364	Schokoröllchen 10 cm	225 Stk
u.v.m.		

# Gelatop



## Drachenfrucht



- Drachenfrucht ist eine asiatische, exotische Frucht
- Pinke Schale, weißes oder rotes Fruchtfleisch
- Milchsäuerlicher, fruchtiger Geschmack
- Drachenfrucht Eis ist ein perfekter Mix aus dem fruchtig-frischen Aroma dieser außergewöhnlichen Frucht
- Super Farbe, super Konzept
- Hervorragender Geschmack

## Marshmallow



- Gelatop und HARIBO haben gemeinsam eine neue Eissorte entwickelt: **Marshmallow**.
- Milcheis Marshmallow wird kombiniert mit dem fruchtigen Marmor-Erdbeere und den leckeren, bunten, frischen HARIBO Chamallows.
- Dies ist ein Knüller und ein Hingucker in jeder Eistheke.

## Variegato



- Hygienisch – Sparsam – Schnell**
- Einfache und tropffreie Dosierung
  - Direkt aus der Flasche zu verarbeiten
  - Verbrauch wird um mehr als 50 % reduziert
  - Läßt sich einfach und schnell einarbeiten
  - Brillante Farbe, intensiver Geschmack – perfekt auf die Kombination mit Eis abgestimmt!



## Basen

31341	Briogel M 133	2,5 kg
31345	Briogel MP cf 110	15 kg
31356	Base 50 Fiordilatte 193	2 kg
31351	Complet L f 131	15 kg
31360	Fruicrem M 145	2 kg
31361	Limone Limone 121	2 kg
31362	Limone M 117	2,5 kg
31355	Milkapan M cf 146	2 kg
31399	Peryo Yogurt 118	2 kg



## Flash-Produkte

31446	Anguria flash 167	1,2 kg
31410	Fragola flash 172	1,2 kg
31412	Lime flash 179	1,2 kg
31414	Mela verde flash 174	1,2 kg

## Toppings

31381	Caffe 302	1 kg
31382	Caramel 303	1 kg
31383	Cioccolato 304	1 kg
	Fragola 305	1 kg
31445	Kiwi 306	1 kg
31384	Lampone 319	1 kg
31385	Mirtillo 320	1 kg
	Nocciola 322	1 kg
31393	Tropical 321	1 kg

## Variegato / Sonstiges

31390	Amarena-Kirschen TF 822	5,5 kg
31394	Amarena-Kirschen TF 801	5,5 kg
34483	Amarena-Variegato m.F. 912	3 kg
31386	Bischoko-Variegato 623	2,5 kg
31387	Crema Nocciocao Varieg. 430	5,5 kg
31340	Crema Napolitaner Loacker 618	5 kg
31388	Pescarancia Variegato 607	3 kg
31389	Tuttobosco Variegato 605	3 kg



### Diabatiker-Produkte

31363	ACE light 175	1,2 kg
31364	Aloe-Vera light 184	1,2 kg
31405	Ananas light 178	1,2 kg
31416	Vanille light 187	1,25 kg

### Eispasten

31365	Ananas 703t	3 kg
31368	Banane o.F. 705	3 kg
31372	Crema Nocciola Acqui	5,5 kg
31375	Caffe Gelateria 446	3 kg
31376	Cocco Gold 461	2 kg
31431	Cacao 468	5,5 kg
31366	Fragola 706t	3 kg
31369	Fragola o.F. 706	3 kg
31377	Fiocco Azzurro 453	3 kg
31370	Lampone o.F. 710	3 kg
31429	Kiwi 709i	3 kg
31436	Gianduia 408	5,5 kg
31367	Melone 713t	3 kg
31371	Mirtillo o.F. 714	3 kg
31378	Malaga 449	3 kg
31379	Menta 450	3 kg
31425	Mela Verde 712t	3 kg
31430	Mango 711i	3 kg
31437	Mandorla 441	5,5 kg
31426	Pesca 717t	3 kg
31433	Pistacchio I 474	2,5 kg
31373	Stracciatella 456	5,5 kg
31374	Tiramisu 418a	2,5 kg
31440	Tartuffo 407	5,5 kg
31441	Torroncino 419	5,5 kg
31380	Vaniglia Classica 428	3 kg
31392	Waldmeister 473	3 kg
31443	Walnuss 415a	2,5 kg

### Strukturverbesserer

31419	Fibramix 202	2 kg
31420	Proteinmix 203	1,6 kg
31418	Softella 201	5 kg



## Pulver

33025	Base Divina 06019	2 kg
33024	Base Elena 02136	1,8 kg
32947	Base Frutta Frutta 06012	8 kg
31105	Base Soave 02121	2 kg
33026	Fiocco di Neve 02020	10 kg
32348	Gelmix 06003	3 kg
39090	Limoncello 100 08041	10 kg
32997	Mec Plus 06007	2,5 kg
32371	Neutralin 06005	1 kg
32360	Neutralin SB 06002	2,8 kg
32531	Pan Mec F 08020	6 kg
32392	Panna Base 02096	2,5 kg
33420	Panna Base 02120	20 kg
39068	Panna Base Super 02090	2,5 kg
39072	Panna Base Super 02190	20 kg
32996	Protomec 06006	2 kg
32697	Schokolade 08008	2 kg
32811	Soffice 06071	3 kg
32813	Soja Vanille m. Weizenkleie	1,25 kg
32815	Sojagel Schokolade 05153	1,25 kg
32794	Sojagel Vanille 05151	1,25 kg
39043	Somix 06077	2,5 kg
32828	Super Gelmix 06004	3 kg
32320	Sweet Tiramisu 08010	2 kg
32224	Tuttopanna 02003	2 kg
30108	Tuttopanna 02203	20 kg
33547	Tuttopanna F50 02111	10 kg
32356	Tuttopanna 100 CD 02005	2 kg
32362	Tuttopanna 100 CD 02015	20 kg
32356	Tuttopanna F100 02005	2 kg
31619	Tuttopanna F100 02153	20 kg
33753	Yoghin 08011	1 kg
33790	Yoghin probiotisch 08082	1 kg
32364	Zitrone Sizilia 08006	1 kg





## Pasten Milcheis

32370	Amaretto 14018	5,5 kg
31163	Biscotino Cookies 14094	4,5 kg
32736	Bubbly 14008	5 kg
31453	Cappuccino 14005	2,5 kg
32230	Caramel 14019	4,5 kg
32238	Cioccomania 14348	2 kg
32856	Cola 14270	5,5 kg
39086	Crema Catalana 14315	5,5 kg
32703	Crema Italiana 14145	4,5 kg
33241	Cuore di Panna 14065	4,5 kg
31082	Dolce Latte Konz. 14046	2,5 kg
33672	Eierlikör vov 14004	5,5 kg
32696	Gianduia 14022	5,5 kg
32873	Haselnuss Maxima 14062	4 kg
32998	Haselnuss Princi. fein 012	5 kg
32251	Haselnuss Prima grob 078	5,5 kg
32745	Haselnuss Piemont 14011	5 kg
32239	Himmelblau 14037	5 kg
32240	Himmelblau natur 14049	5,5 kg
32344	Kokosnuss 14020	4 kg
32852	Krokant mit Rum 14033	5,5 kg
32337	Malaga 14015	5,5 kg
32659	Marzipan 14034	5,5 kg
32660	Mister Nico 14220	4 kg
33033	Mocca Espresso 14090	5 kg
33616	Mocca Extra 14416	2,1 kg
32380	Pfefferminz m.F. 14035	2,5 kg
32394	Pfefferminz Natur 14074	2,5 kg
32816	Pina Colada 14260	5,5 kg
32361	Pistazie Gr.Pokal fein 080	5,5 kg
32383	Pistazie Gr.Pokal grob 026	5,5 kg
33619	Pistazie Sizilia 100% 052	4 kg
39087	Roche 14083	6 kg
32340	Scrok 14304	4,5 kg
32347	Sesam 14607	4 kg
39048	Tiramisu 14302	5,5 kg
39049	Tiramisu o. Alkohol 14338	4 kg
32358	Trüffel Baci 14023	5,5 kg
32365	Vanille 14038	4,5 kg
31011	Vanille II 14119	4,5 kg
32812	Vanille Bourbon 14039	4,5 kg
33614	Vanille Delicieux 14144	4,5 kg
33613	Vanille Premium 14056	4,5 kg
33673	Walnuss Premium 14126	4 kg
33675	Weißer Schokolade 14092	6 kg
39034	Weißer Glescherminze 041	5,5 kg
32810	Weißer Trüffel 14021	5,5 kg
32325	Zabajone 14014	5,5 kg
32827	Zimt 14280	5,5 kg
32319	Zuppa Inglese 14044	5,5 kg



### 500er Produkte

33739	ACE 500 08105	1,25 kg
33229	Ananas 500 08071	1,25 kg
33240	Blutorange 500 08095	1,25 kg
33696	Grüner Apfel 500 08080	1,25 kg
39037	Kokos 500 08050	1,25 kg
39036	Limoncello 500 08040	1,25 kg
33697	Melone 500 08069	1,25 kg
33783	Pfirsich 500 08060	1,25 kg
33740	Waldbeere 500 08072	1,25 kg
33027	Wassermelone 500	1,25 kg
33741	Yoghin 500 08065	1,25 kg
33789	Zitrone 500 08001	1,25 kg

### Pasten Fruchteis

32372	ACE 18097	2,5 kg
32373	Ananas 18057	2,5 kg
33663	Ananas 18028	7 kg
32332	Aprikose 18060	2,5 kg
32331	Banane 18056	2,5 kg
33664	Banane 18030	7 kg
33754	Blutorange 18038	2,5 kg
32357	Erdbeere 18046	2,5 kg
33665	Erdbeere 18035	7 kg
32808	Grüner Apfel 18099	2,5 kg
32330	Heidelbeere 18049	2,5 kg
33835	Heidelbeere 18011	7 kg
32315	Himbeere 18048	2,5 kg
33667	Himbeere 18012	7 kg
32369	Kirsche 18053	2,5 kg
32339	Kiwi 18062	2,5 kg
32344	Mango 18054	2,5 kg
32333	Maracuja 18061	2,5 kg
32229	Melone 18058	2,5 kg
33668	Melone 18027	7 kg
32351	Orange 18059	2,5 kg
32387	Papaya 18079	2,5 kg
33254	Pfirsich 18067	2,5 kg
39085	Pflaume 18041	2,5 kg
39047	Tropical 18063	2,5 kg
32412	Waldbeere 18069	2,5 kg
33678	Wassermelone 18098	2,5 kg





## Saucen im Kanister

39071	Caramel 24387	8 kg
32830	Erdbeere 24381	8 kg
32838	Schokolade 24380	8 kg
33829	Tropical 24384	8 kg

## Diabetiker Produkte

32740	Difruit 12103	2,8 kg
32363	Dischok 12104	2,8 kg
32739	Divan 12101	2,8 kg
32756	Diyog 12105	2,8 kg

## Toppings

33674	Amarena 24013	1 kg
32796	Ananas 24101	1 kg
32795	Banane 24105	1 kg
32345	Caramel 24087	1 kg
33655	Curacao rot 24103	1 kg
33238	Dolce Latte 24047	1 kg
32366	Erdbeere 24081	1 kg
32793	Grüner Apfel 24106	1 kg
32375	Haselnuss 24091	1 kg
32378	Heidelbeere 24089	1 kg
32698	Himbeere 24082	1 kg
32335	Kiwi 24085	1 kg
33256	Kirsche 24083	1 kg
32787	Melone 24110	1 kg
32368	Mocca Kaffee 24086	1 kg
33755	Nocciolosa 24114	1 kg
32979	Pfefferminz grün 24109	1 kg
32850	Schokolade 24080	1 kg
32792	Schoko-Minz 24108	1 kg
32858	Tiramisu 24092	0,9 kg
32814	Tropical 24084	1 kg
32401	Vanille 24096	1 kg
32755	Waldbeere 24095	1 kg
32754	Walnuss 24104	1 kg
32367	Zabajone 24088	1 kg
32948	Dia Erdbeere 24502	1 kg
39038	Dia Schoko 24501	1 kg







## Variegati

32863	Amarena o. Farbe	2,5 kg
33647	Ciocconut 14167	6 kg
33022	Cocomio 14087	6 kg
32859	Copatura al Latte 14081	4 kg
31160	Cookies 14322	6 kg
31083	Dolce Latte Creme 14087	3 kg
33030	Fior di Albicocca 18064	2,5 kg
33629	Fior di Anrancio 18091	2,5 kg
33636	Fior di Bosco 18070	2,5 kg
33644	Fior di Pesca 18095	2,5 kg
33669	Fior di Fragola 18075	2,5 kg
33623	Fior di Lampone 14143	4 kg
32505	5-Korn Variegato dkl. 14170	4 kg
32510	5-Korn Variegato weiß 14175	4 kg
32503	Himbeer o. Zucker 14141	2,5 kg
32241	Kirsche m. Farbe 18084	2,5 kg
32499	Kirsche o. Zucker 14136	2,5 kg
32843	Limetta 14343	1,5 kg
33676	MecCherry 14305	4 kg
33677	MecRocher plus 14318	5 kg
39088	Mou 14311	2,5 kg
33681	Mister Nico 14225	4 kg
32346	Nocciolosa 14063	6 kg
32699	Nocciolcreme 14058	6 kg
32377	Pannacotta 14066	5 kg
33645	Tiramisu 18044	4 kg
33666	Tiramisu o. Alkohol 14373	4 kg
32359	Stracciatella 14028	6 kg
33670	Stracciatella Flaschen 14121	6 kg
33622	Whisky Crem 14303	6 kg



## Dekor

32385	Amarena-Kirschen 26130	2,75 kg
32918	Frollini-Biskuit 16047	0,7 kg
39089	Erdnuss-Streusel 16055	6 kg
32957	Granella di Scrok 16050	1 kg
31084	Granella Mix 2000 16070	1 kg



### Mec3-Kits

33325	Amadeus Kit 14400	12,1 kg
33247	Cannolo Kit 14331	11 kg
32817	Carapino Kit 14290	5,5 kg
33249	Cherry Mania Kit 14350	6,5 kg
34218	Chokissimo Kit 14365	6,9 kg
33671	Cocomio Kit 14330	10 kg
31464	Cookies Kit 14324	10,5 kg
31979	Cookies Kit CBF 14354	11,2 kg
33324	Creme Brule Kit 14377	8,5 kg
31081	Dolce Latte Kit 14130	10,5 kg
33296	Don Vito Kit 14376	8,6 kg
33612	Energy Kit 14389	9,6 kg
33248	Kinde Kit 14334	4,6 kg
32991	Limetta Kit 14339	11,9 kg
33297	Mister Nico Kit 14383	9 kg
32993	Raffy Kit 14333	10,5 kg
33794	Sesam öffne Dich Kit 14407	9 kg
33788	Spekulatius Kit 14355	10 kg
33695	Wafer Kit 14351	9 kg
31479	Whisky Crem Kit 14332	10,5 kg



### Sonstiges

31551	Belfrutta 18109	5 kg
31552	Gelato Caldo 13104	2 kg
32354	Softin 06070	5 kg
33787	Dr. Scotti Chiocco cioc 08702	18 kg
33795	Dr. Scotti Chiocco Vani 08710	16,2 kg
33796	Dr. Scotti Flan di Riso 08708	17,4 kg
33793	Dr. Scotti Nocciol Croc 08704	18 kg



### Elenka

32804	Elenka Arancio	2,7 ltr
32800	Elenka Mokka Kof-Kof	2,7 ltr
31139	Elenka Zitrone + Bonificato	2,75 ltr
32806	Elenka Zuppa Inglese	2,6 ltr

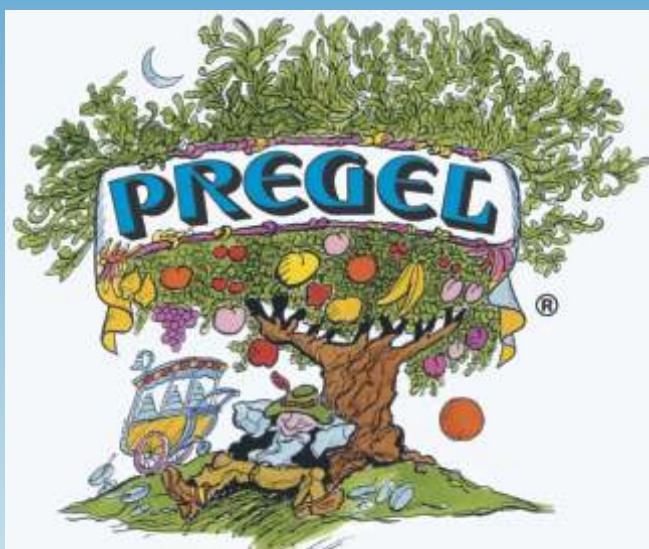

## Pulver

31087	Base Aura 50 06608	12 kg
31073	Base Aura 100 06708	12 kg
31567	Base Cadorina 50 24108	12 kg
31002	Base Soja Neutral 09408	16 kg
31455	Base Vittoria 100 08408	1,5 kg
32163	Dolomiti Base 01548	16 kg
32146	Dolomiti Van 06348	2 kg
32779	Eivanill kalt 07908	2 kg
32118	Eivanill warm 08008	2 kg
32132	Everest Base 50 00148	16 kg
33748	Fibra plus 00408	12 kg
32116	Fior Panna 02208	12 kg
31177	Geloglass 65476	7,2 kg
31178	Granfruttosa 23908	16 kg
32763	Jolly 02648	16 kg
33737	Joghurt light Erdbeer 36601	11,04 kg
32772	Limoncello 08504	2 kg
31176	Maximapan 150 07008	12 kg
31747	Morbidex 02108	16 kg
32139	Neutro 02008	16 kg
32200	Pannapiu 02848	2 kg
31001	Pannagel C 02348	16 kg
31010	Pannalpina 00744	8 kg
33749	Piu Cremosa 00308	12 kg
32966	Pregellina 2 79804	2 kg
33095	Proteingel 08804	6 kg
31179	Pronto Tiramisu 35008	12,8 kg
32098	San Fresh 70208	1,5 kg
31052	Soffiopan Neutro 65704	6 kg
31053	Soffiopan Joghurt 65804	6 kg
32122	Tiramisu/Tirapone 66404	1,5 kg
33094	Totalbase 09308	12 kg
32099	Yogomix 03804	6 kg
32102	Zitrone 04048	16 kg

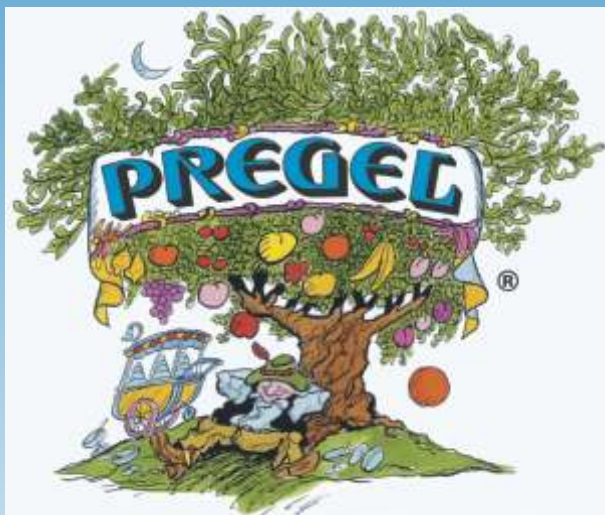

## Milcheis-Pasten

31054	Alpenkaramel 27406	7,8 kg
32152	Amaretto 50002	6 kg
32168	Amadeus Dream 10802	6 kg
31006	Bubble Gum 53072	3 kg
31470	Butterkeks 25602	3 kg
32134	Cacaopat 56522	6 kg
31110	Caffe Costa D'Oro 28002	6 kg
32860	Caramel Mou 57202	6 kg
32115	Caramello 50202	6 kg
32781	Ciocolatino 59302	5 kg
32934	Crokantino al Rum 50672	3 kg
32093	Donatella 54802	6 kg
32129	Engelblau m. Farbe 12302	6 kg
32135	Espresso 53676	6,6 kg
32429	Erdnuss Arachio 24502	2,5 kg
32119	Gianduia 50702	6 kg
31855	Irish Coffee 24002	3 kg
32112	Haselnuss Regina fein 51402	5 kg
32128	Haselnuss Regina grob 58202	5 kg
32104	Kokosnuss 50402	5 kg
31008	Latte Macchiato 27502	6 kg
32120	Malaga 59902	6 kg
32198	Mandel geröstet 55202	6 kg
32137	Marzipan 51002	6 kg
32956	Mascarpone 29402	6 kg
32100	Moretto Mokka 50102	6 kg
31164	Nocciola Scura Elite 27002	5 kg
31165	Nocciola Braun fein 29202	5 kg
32144	Omas Apfelkuchen 57802	3 kg
31481	Panna Panna 53302	6 kg
32061	Pannacotta 54702	6 kg
32744	Pfefferminz m. Farbe 51102	6 kg
32105	Pistazie Real fein 59702	6 kg
32821	Pistazie Real grob 59602	6 kg
32829	Pistazie Creme 57102	6 kg
32824	Pistazie Rein Sizilia 55972	2,5 kg
31009	Prontociocc 28322	6 kg
32845	Tartuffo Bianco 53402	5 kg
32101	Tartuffo Bacio 51902	5 kg
32086	Tiramisu 52006	1,3 kg
32738	Torrone 52102	4 kg



## Milcheis-Pasten

32703	Vanille 59502	6 kg
32741	Vanille Antica N 57402	6 kg
33849	Vanille Classica 902	6 kg
33155	Vanille Classic Bourbon 602	6 kg
32249	Vanille dekl.frei 802	6 kg
33232	Vanille Mexico 26402	6 kg
33239	Vanille Pur. Bacche 23502	3 kg
33237	Vanille Tahiti 49802	6 kg
32825	Waldmeister m. Farbe 56902	6 kg
32145	Walnuss mild 53202	6 kg
32125	Walnuss herb 51202	6 kg
32203	Weiße Schokolade 55502	5 kg
32820	Zabajone 58906	1,3 kg
32088	Zimt 58472	3 kg
32117	Zuppa Inglese 59472	6 kg

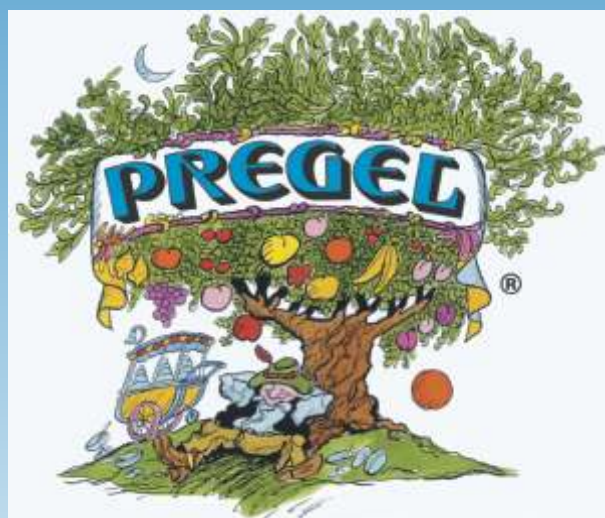

## Fruchteis-Pasten

32136	Ananas Frucht 45272	3 kg
32111	Aprikose Frucht 45072	3 kg
31012	Banane dekl.frei 42372	3 kg
32106	Erdbeere Frucht 45872	3 kg
32051	Exotic Cocktail 49272	3 kg
32159	Grüner Apfel Frucht 45172	3 kg
32108	Himbeere Frucht 46272	3 kg
32164	Kirsche Frucht 45672	3 kg
32581	Kiwi Frucht 46172	3 kg
32141	Mango Frucht 47772	3 kg
32142	Maracuja Frucht 46072	3 kg
32107	Melone Frucht 47972	3 kg
32109	Orange Frucht 45372	3 kg
32124	Papaya Frucht 46972	3 kg
32126	Pfirsich Frucht 47072	3 kg
31109	Pfirsich-Mango ACE 49372	3 kg
32943	Sauerkirsche Frucht 43372	3 kg
33292	Schwarze Johannisb. 47372	3 kg
32835	Waldbeere Frucht 45972	3 kg
32992	Walderdbeere N 47572	3 kg
32758	Weintraube Frucht 43072	3 kg
33435	Zitrone Mediterraneo 41356	7,8 kg



## Sprint-Produkte

31566	Ananas Sprint 36501	13,2 kg
31568	Agrumace Sprint 32805	13,2 kg
31572	Aloe Vera Exotic 22901	13,2 kg
31564	Barbie Sprint 21701	13,2 kg
31582	Banane Creme Sprint 35501	12 kg
31577	Bianco Latte Sprint 32355	11,04 kg
31570	Chili-Schoko Sprint 37801	13,2 kg
31576	Blutorange Sprint 37001	13,2 kg
31579	Erdbeer Sprint 01201	13,2 kg
31578	Fragolananas Sprint 01201	13,2 kg
32341	Grüner Apfel Sprint 35301	13,2 kg
31581	Himbeer Sprint 31355	13,2 kg
31565	Kokos Sprint 06901	11,04 kg
31861	Kiba Sprint 21601	13,2 kg
31857	Limette Sprint 23001	13,2 kg
31856	Mandarine Sprint 23801	13,2 kg
31162	Mascarpone Imperiale 05001	12 kg
32329	Melone Sprint 35401	13,2 kg
32334	Pfirsich-Mango Sprint 37101	13,2 kg
31007	Quarcream Sprint 05901	11,04 kg
31219	Tiramisu Sprint 35701	12 kg
31580	Schokolade Sprint 32401	12 kg
31171	Vanille Sprint 32501	12 kg
31175	Wassermelone Sprint 31701	14,4 kg
31172	Yoghurt Sprint 32901	12 kg
33584	Yoghurt-Waldbeer Sprint	12 kg

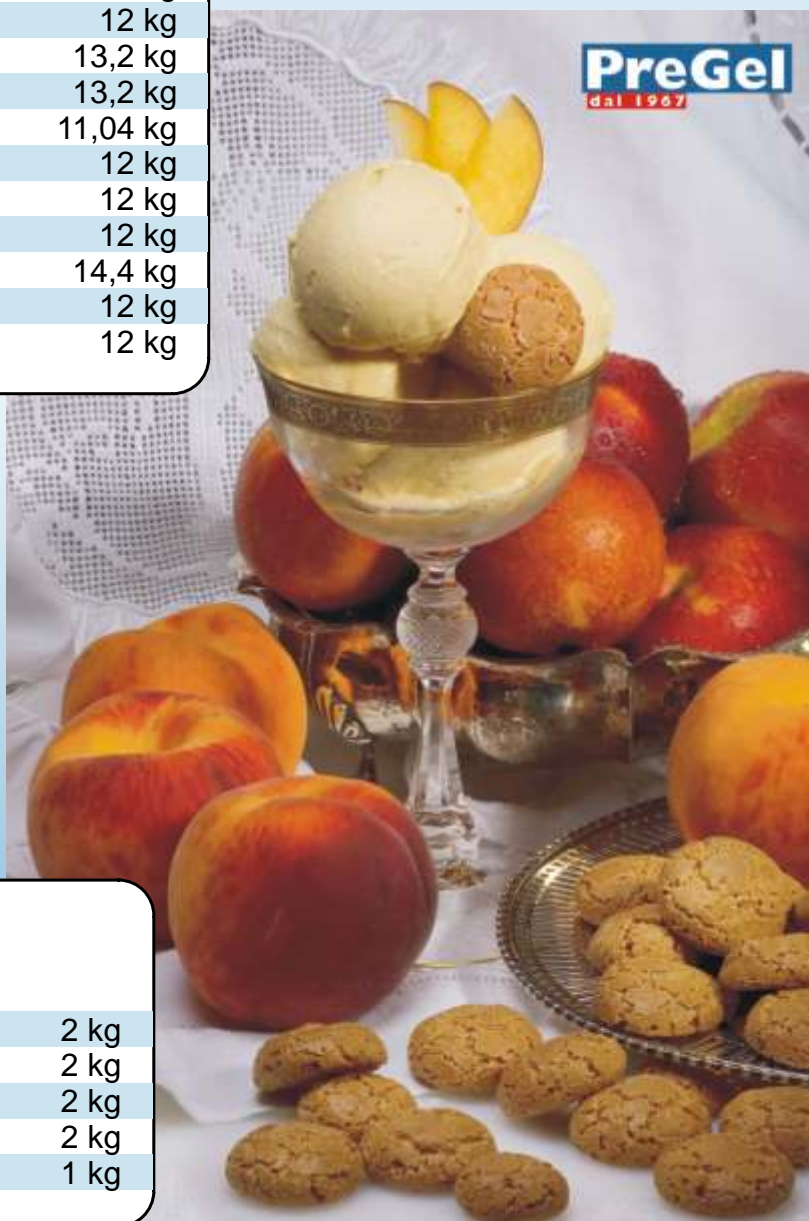
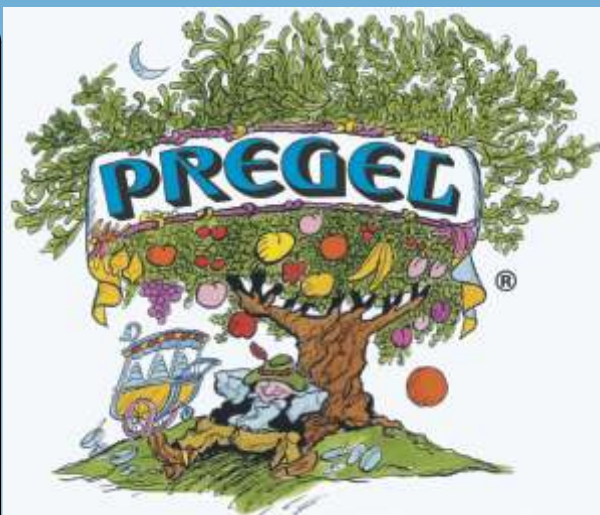

## Diabetiker-Produkte

32932	Dia Base Frucht 08108	2 kg
32931	Dia Base Joghurt 08308	2 kg
32933	Dia Base Milch 08208	2 kg
32940	Dia Base Vanille 08708	2 kg
32929	Dia Waldbeer Topping 13206	1 kg



Copyright PreGel 2000

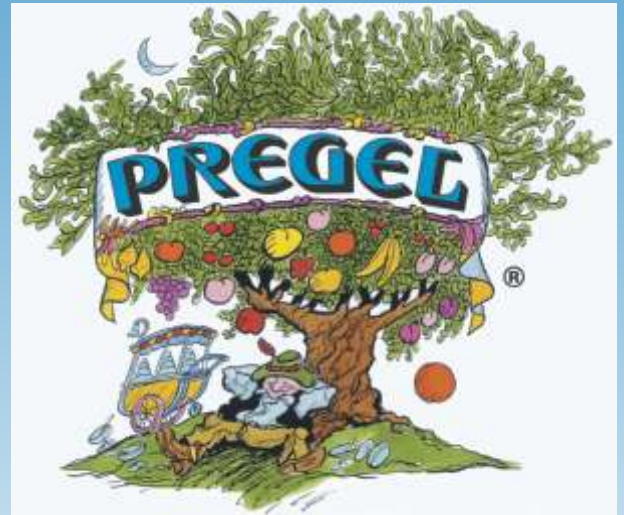

## Toppings

32167	Amarena 10006	1 kg
32443	Amaretto 22406	1 kg
31017	Banane 19206	1 kg
32784	Kokos 18006	1 kg
31018	Blutorange 19606	1 kg
32958	Ciliegia 18706	1 kg
31014	Curacao Blue 11306	1 kg
31015	Curacao Rot 19506	1 kg
32154	Erdbeere 10306	1 kg
32156	Himbeere 10506	1 kg
32169	Heidelbeere 44106	1 kg
31118	Honig 19006	1 kg
32147	Karamel 10106	1 kg
32582	Kiwi 10406	1 kg
32130	Mango 11106	1 kg
31020	Maracuja 19406	1 kg
32157	Mokka-Kaffee 10706	1 kg
29837	Mou 19906	1 kg
31186	Pfefferminz 18606	1 kg
31019	Pfirsich 19706	1 kg
32155	Schoko 10206	1 kg
31016	Vanille 19306	1 kg
31013	Waldbeere 11506	1 kg
32771	Weintraube 13106	1 kg
32151	Zabajone 10606	1 kg

## Arabeschi

32782	Amarena 12002	3 kg
31112	Apfel 16902	3 kg
31113	Aprikose 17104	3 kg
31859	Baiser Meringa 36302	0,7 kg
31187	Bigne+Cioccola 71302	11 kg
32976	Bitterschokolade 12406	0,9 kg
31021	Blutorange 15902	3 kg
31024	Butterkeks 27122	3 kg
33428	Caramellatte 16142	3 kg
31173	Coffe Crunch 17402	6 kg
31140	Cristall Berry 16702	3 kg
32955	Donatella 13806	0,9 kg
33177	Donatella Rock 13402	5 kg
31023	Fragolissima 71002	6 kg
31037	Feige 17502	3 kg
31275	Gianduione 16305	6 kg
31276	Haselnuss Praliné 17802	2,5 kg
31860	Heidelbeere 21802	3 kg
31863	Himbeere 21802	3 kg
31574	Ingwer 78502	3 kg
31114	Kirsche 16802	3 kg
31858	Mandel 78702	2,5 kg
33854	Mandarino 06402	3 kg
31022	Milchreis Ris & Latte	4 kg
31875	Nocciola 13906	0,9 kg
31878	Nocciolatte 53802	3 kg
31877	Omas Apfelkuchen 802	3 kg
32171	Pfirsich-Orange 12602	3 kg
31117	Pflaume 17002	3 kg
32547	Pistazie 22706	0,9 kg
32942	Sauerkirsche 12902	3 kg
32946	Tutti Frutti Cristal 38101	4 kg
31468	Schoko + Cerealien 702	2,5 kg
31483	Schoko + Waffeln 78602	2,5 kg
31482	Stracciatella 26502	5 kg
32195	Waldbeere 12704	3 kg
33429	Wald-Erdbeere 12102	3 kg
33434	Weißer Schokolade 602	2,5 kg

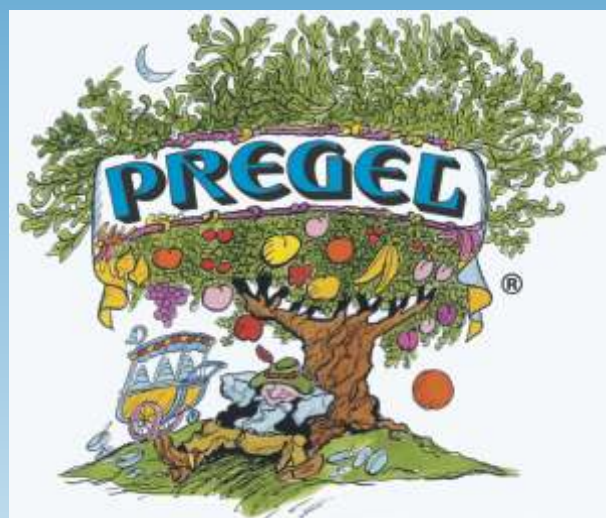



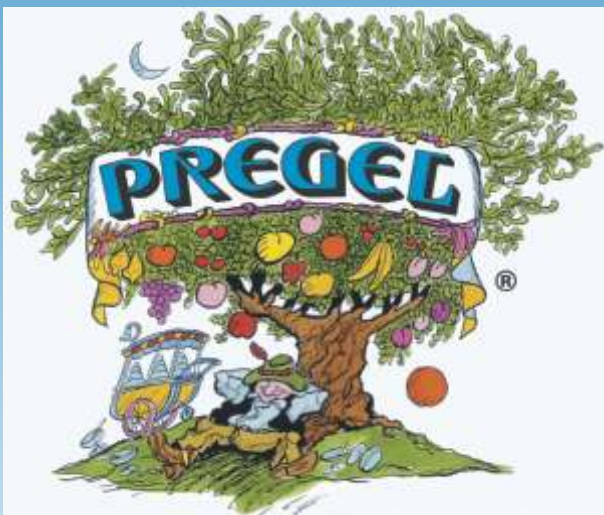

## Dekor

32153	Amarena-Kirschen 71204	5,6 kg
31188	Arcobaleno 70301	4 kg
31486	Centorighe Schoko 14476	1,2 kg
31004	Coriandoline Erdbeer 28804	2,75 kg
31854	Schoko-Butterkekse 37302	1,5 kg
31125	Sesam Krokantstreusel 706	1 kg

## Sonstiges

31120	Caffe Ice-Drink 62601	11,52 kg
33092	Crema Ca'd'Oro 67248	1,5 kg
31189	Heiße Schokolade 71801	6 kg
32096	Kaffee-Tunke 62276	1,3 kg
32097	Ovissimo 70506	1,35 kg
32989	Pregellina Pastapronta 79702	6kg
32138	Vellutina 70402	5 kg
33436	Amadeus-Kit 38404	12,8 kg
33437	Boero-Kit 38902	11 kg
33438	Leo Leon-Kit 38504	11 kg
33439	Fior di Latte Soft 03108	12,8 kg



## Zubehör

33284	Eislöffel Gelato 3008	10 kg
31759	Coppa Fantasia 350 ccm 3000	660 Stk
33270	Coppa Fantasia 450 ccm 3001	600 Stk
33786	Coppa Fantasia 550 ccm 3010	600 Stk
33271	Coppa Noe 120 ccm 3003	900 Stk
33272	Coppa Noe 220 ccm 3004	600 Stk
33277	Coppa Noe 300 ccm 3005	650 Stk
33283	Coppa Noe 400 ccm 3006	600 Stk

## Pulver

33618	Fior di Panna 91173	2 kg
31086	Base Nuvolatte 50 91793	12 kg
32977	Yoghurt 93393	2 kg

## Eispasten

33652	Amaretto fluido 92141	5,5 kg
32971	Celestino 92043	7 kg
39012	Erdbeere Frucht 94003	5 kg
39000	Gianduia 92161	6 kg
31107	Gran Caffè / Espresso	5 kg
33635	Haselnuss grob 92463	10 kg
39001	Haselnuss fein 92543	10 kg
32049	Karamel 92111	3 kg
39025	Kokos 99601	4 kg
32150	Krokant mit Rum 92181	5,5 kg
32035	Malaga Gran Marca 92353	7 kg
33043	Martinica Tartufata 93231	5,2 kg
32027	Melone 93481	3,5 kg
32005	Menta grün 93543	3 kg
32036	Menta weiß 93511	7 kg
33826	Monte Cristallo 92423	6 kg
39261	Nocciola fluida chiara 92661	5,4 kg
39030	Nocciola fluida scura 92601	5,4 kg
39105	Pistazie pura Sizilia 92751	2,5 kg
39003	Pistazie Gran Marca 92803	5,5 kg
32047	Stracciatella 93243	5,5 kg
39026	Tiramisu 93311	5 kg
32013	Torrone Gran Marca 92881	4,5 kg
33643	Tartufo gioia mia 92261	5,5 kg
39122	Vanille 93563	3 kg
39004	Vanille Gran Marca 93573	7 kg
32039	Walnuß Gran Marca 92703	5,5 kg
33838	Zabajone 93093	4,8 kg



## Sonstiges

32034	Amarenata Kirschen 98463	7 kg
39010	Amarena Variegato 95731	9 kg
32953	Crocchi 98731	5 kg
39023	Haselnüsse geröstet 98051	2 kg
32057	Macedonia di Frutta 98343	5 kg
32161	Cacao 20-22% 90023	1 kg

## Pasten

34054	Copertura 1510	5 kg
34055	Copert. Torrone 70018	4,5 kg
34056	Gianduia 1020	6 kg
34057	Giava Vanille 70101	6 kg
34058	Haselnuss Aurum 70090	5 kg
34059	Haselnuss T.F. 70075	5 kg
34060	Haselnuss fein 3000	5 kg
34061	Kokosnuss 1760	6 kg
34062	Milady (Schoko-Nuss) 1130	6 kg
35063	Mokka-Caffè 1600	6 kg
35064	Pasta Oro (Ei) 70011	6 kg
35065	Perdue weiß 1100	5 kg
35066	Pistazie Jupiter 2010	5 kg
35067	Premier 1440	5 kg
34068	Tiramisu 1820	6 kg
34069	Walnuss 1580	6 kg
34070	Zabajone 1680	5,5 kg
34071	Zabajone natürl. 1700	5,5 kg
34072	Zuppa Inglese 1840	5,5 kg
34073	SF Banane 70713	3 kg
34074	SF Erdbeere 70433	3 kg
34075	SF Grüner Apfel 70437	3 kg
34076	SF Melone 70423	3 kg
34077	SF Menta Più 70402	6 kg



## Variegati

34080	Cioccotella 70613	3 kg
34081	Rubino 70457	3 kg

## Pulver

34050	Bibase c/f 70311	8x1,5 kg
34051	Frubest 50g 8241	8x1,5 kg
34052	Fruit 100g 6261	8x1,5 kg
34053	Zitrone 400g 8274	12x1,1 kg

## Dekor

34085	Granella all` Amaretto 2160	5 kg
34086	Grancrock 2180	5 kg





## Eiszutaten

33160	Emulgator Morbido	10 kg
34016	Haselnusspaste fein	10 kg
34017	Haselnusspaste grob	10 kg
34018	Stracciatella Fettglasur	10 kg

## Toppings Kanister

32059	Amarena-Sirup	7 ltr
32223	Schoko-Sirup	7 ltr



## Dekor

32032	Amarettini-Mehl	4 kg
32031	Amarettini-Plätzchen	2 kg
32945	Amarettini-Streusel	4 kg
34019	Dragee-Streusel	2,5 kg
34026	Haselnusskrokant-Streusel	3 kg
32912	Schokosplitter	5 kg
32913	Torroncino-Streusel	5 kg
34015	Haselnüsse Cuneo ganz, geröstet	2 kg
34023	Haselnüsse Cuneo gehackt, gerös.	2 kg
34034	Haselnuss-Stücke karamellisiert	2,5 kg
32074	Walnuss-Stücke karamellisiert	0,5 kg
32704	Walnuss-Stücke karamellisiert	1,5 kg
34013	Löffelbiskuit 9x400 g	3,6 kg





## Pulver

31062	Base Frucht 3804	5 kg
31063	Base Milch 3803	5 kg
33742	Base Z 100 3831	20 kg
	Base 2000 3731	10 kg
	Base 3000 3283	5 kg
32777	Pannagel m. Sahnepulver	5 kg
32780	Rapida Lemon Icetea 3459	5 kg
32652	Sauermelk-Joghurt 3770	5 kg
32463	Vanille Eispulver 3766	5 kg
27840	Vani Star 1363	1 kg
32491	Yoghurt Eispulver 3783	5 kg

## Softeispulver

33243	Erdbeer-Pulver 2574	10 kg
33252	Schoko-Pulver 3756	12,5 kg
33215	Vanille-Pulver 3735	10 kg



## Eispasten

33045	Amarena 2820	3 kg
33034	Banane 2844	3,5 kg
32512	Bubble Gum 2812	3,5 kg
33044	Curacao Blue 3013	3,5 kg
32702	Erdbeere 2837	3,5 kg
32492	Haselnuss Italia, grob	5 kg
32662	Haselnuss Italia, fein	5 kg
	Himbeere 2845	3,5 kg
	Honigmelone 2681	3,5 kg
33035	Grüner Apfel 3003	3,5 kg
33041	Guanabana 2688	2,8 kg
32682	Karamel / Butterscotch	3,5 kg
32691	Kokos 2861	3,5 kg
32669	Malaga 2852	3,5 kg
32670	Maracuja 2835	3,5 kg
32826	Mokka 2032	3,5 kg
32686	Orange 2841	3,5 kg
32666	Pfefferminz 3002	3,5 kg
	Pistazie 100% 2818	3 kg
32693	Schokolade	3,5 kg
	Tiramisu 2833	3,5 kg
32688	Vanille 2857	5 kg
32690	Vanille Classica 2534	3,5 kg
33091	Vanille SuVaniglia 9482	5 kg
32694	Waldbeeren 2801	3,5 kg
32975	Waldmeister 3014	3,5 kg
32687	Walnuss 2853	3,5 kg
32692	Zabajone 2855	3,5 kg



### Variegati

33038	Amarena 3203	5,6 kg
33625	Biscotella 2028	3 kg
33279	Caramel 1681	1,45 kg
	Erdbeere 2328	2,9 kg
	Pfirsich-Orange 2408	2,9 kg

### Toppings

32480	Amarena 3094	1 kg
32685	Banane 3109	1 kg
32481	Erdbeere 3091	1 kg
32487	Gianduia 3098	1 kg
32482	Himbeere 3093	1 kg
32570	Karamel / Butterscotch	1 kg
32623	Kiwi 3099	1 kg
32483	Maracuja 3095	1 kg
32489	Mokka 3114	1 kg
32624	Nuss 3160	1 kg
32485	Schoko 3096	1 kg
32791	Waldbeere 3103	1 kg



### Toppings Kanister

32488	Amarena 3094	10 kg
32494	Erdbeere 3091	10 kg
32490	Gianduia 3098	10 kg
32493	Himbeere 3093	10 kg
32974	Karamel / Butterscotch	10 kg
32470	Kiwi 3099	10 kg
32496	Maracuja 3095	10 kg
32844	Nuss 3160	10 kg
32495	Schoko 3096	10 kg
32788	Waldbeere 3103	10 kg

### Sonstiges

32476	Cortina 3673	5 kg
33039	Amarena-Kirschen 3046	5,6 kg
33162	Kirsch-Dessert 2992	4,8 kg
32636	Rote-Grütze-Dessert 2990	4,8 kg
32451	Stracciatella Fettglasur 3222	10 kg
32486	Sahneis-Aroma 1214	1 kg
32417	Sahneis-Aroma 1214	5,5 kg



FJ-42



FJ-42 Ve

**Spitztüten kurz, ohne Rand**

		Ø	Länge	Stück
32288	FJ-42	50	128	500
32289	FJ-42 E eng	45	128	450
32293	FJ-42 G extra groß	54	140	400
32574	FJ-42 Veneto	61	155	272
32936	FJ-45 Eiskuchen	52	135	500
31963	FJ-46 Firenze	46	148	375
32539	FJ-95 Belluno	55	130	400
32540	FJ-95 G Belluno groß	60	140	320
31106	FJ-96 extra groß	54	140	375

**Spitztüten lang, ohne Rand**

		Ø	Länge	Stück
33214	FJ-42 LS Monza	47	175	275
32284	FJ-42 Long John	55	200	150



FJ-42 LS Monza



FJ 50



FJ 52



FJ 92

**Spitztüten kurz, mit Rand**

		Ø	Länge	Stück
32271	FJ-50 Eiskuchen	50	125	450
32270	FJ-50 E eng	47	125	450
32404	FJ-52 Medium	46	135	450
32309	FJ-53 Maximus	53	160	300
32302	FJ-92 Corona Wellrand	53	135	450

Angaben (Ø und Länge) in mm



FJ 50 LJ



FJ 50 Do

**Spitztüten lang, mit Rand**

		Ø	Länge	Stück
32286	FJ-50 Long John	55	200	150
32545	FJ-50 Dolomiti	42	160	250
32575	FJ-50 LS	47	160	280

**Riesenhörnchen**

		Ø	Länge	Stück
32460	FJ-42 Gino	58	170	224
32297	FJ-42 Longarone Riesen	62	175	224
32275	FJ-42 R Jumbo	68	175	224
32587	FJ-42 Cortina	78	165	192
32298	FJ-42 Skandinavien	95	165	162
32578	FJ-50 R Jumbo m.R.	64	175	208



FJ 42 R



FJ 42 SK



FJ 50 R



FJ 65



FJ 74



FJ 97

**Hörnchen halbsüß**

		Ø	Länge	Stück
32281	FJ-67 Tulpen klein	40	100	950
32280	FJ-65 Tulpen mittel	44	112	700
32279	FJ-66 Tulpen groß	50	115	500
32278	FJ-70 Piccolo	40	105	1000
32272	FJ-74 Caroline	44	112	750
32274	FJ-75 Elke	49	110	720
32273	FJ-77 Heidi	47	105	800
32901	FJ-97 Kronentüte	51	140	600
32544	FJ-111 Doppelkopf	72x40	123	400

Angaben (Ø und Länge) in mm





FJ 94



FJ 85



FJ 175

Waffelbecher		Ø	Länge	Stück
32299	FJ-10 Wiener Schale	85	20	450
32995	FJ-94 Portionsbecher	49	29	1380
32285	FJ-72 Becher 50 ml	64	52	700
32287	FJ-86 Becher 70 ml	64	70	384
32576	FJ-85 Becher groß	68	67	320
32580	FJ-175 Becher 175 ml	83	62	234
32579	FJ-275 Becher 275 ml	95	65	234



FJ 90

Süße Körbchen Croccante		Ø	Länge	Stück
32305	FJ-90 K klein	95	35	60
32304	FJ-90 groß	125	30	60

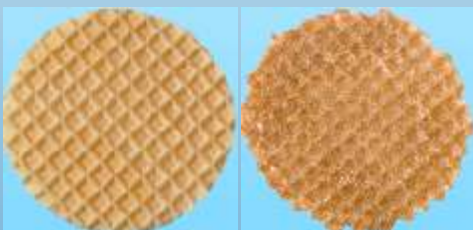

FJ 40

FJ 87

Rundwaffeln		Ø	Länge	Stück
32283	FJ-40 Waffelböden 6 cm	60	60	1000
32314	FJ-87 Knuspertaler	60	60	1000

Angaben (Ø und Länge) in mm



Dekorwaffeln		Ø	Länge	Stück
32257	FJ-22 Waffelstäbchen	-	85	500
32236	OTTO Eiswaffeln Gold	-	112	96 x 8
32294	FJ-82 Hohlhippen 8 cm	10	80	500
31748	FJ-82 Hohlhippen 12 cm	10	120	500
32290	FJ-91 Bärchen	-	92	320
32274	FJ-83 Wellfächer	90	-	200
32263	FJ-83 Herzfächer	90	-	200
32292	FJ-500 Fächer	90	-	500



FJ 83 W



FJ 83 H



FJ 91



FJ 22



Otto



FJ 82/12



Sonstige Waffeln		Ø	Länge	Stück
33775	Knuspertüte La Belle 009	44	140	770
32797	Eishörnchen Capri 037	54	140	420
32798	Supertüte Paris 057	70	250	120
32785	Waffelschalen 092	135	40	90
32789	Eiswaffeln XXL 131		110	400
33173	Auer Rieserhippen	24	128	120
32242	Auer Eiswaffeln		110	500

Angaben (Ø und Länge) in mm

## Rundkuchen und -torten

27865	Apfel Torte 28 cm 2840	2500 g
28939	Apfelkuchen m. Butterstreusel 0482	2000 g
27879	Champagner Torte 28 cm 2958	2000 g
28656	Cointreau-Trüffel Torte 28 cm 4785	1800 g
28938	Erdbeerkuchen 26 cm 2685	1750 g
28627	Erdbeer-Buttermilch Torte 4786	2000 g
29083	Himbeer Cheese-Cake 24 cm 3325	1450 g
27860	Himbeer-Käsesahne 28 cm 0450	2200 g
28694	Käse-Sahne Torte 28 cm 4361	1800 g
27862	Käsekuchen m. Mandarinen 0485	2150 g
28937	Käsekuchen m. Mürbteigrand 4002	2150 g
29579	Kirsch-Joghurt Torte 28 cm 4774	1600 g
27874	Kirsch-Käsesahne Torte 0455	2500 g
29725	Kokos-Tarte 28 cm 1882	1100 g
27861	Mandarinen-Käsesahne 0451	2500 g
29813	Mousse-au-Chocolat Torte 4791	2000 g
28610	Pfirsich-Erdbeer Torte 28 cm 4787	2000 g
28940	Rübli-Torte 28 cm 2540	1500 g
29580	Schokokuchen 24 cm 4881	1000 g
29777	Schoko-Torte 4-Schichten 5286	1900 g
29728	Schoko-Birnen-Tarte 28 cm 3324	1250 g
29729	Schoko-Kuppeltorte 26 cm 4702	1250 g
37871	Schoko-Sahne-Duo 28 cm 0454	2000 g
29800	Schwarzwälder Kirschtorte 4360	2000 g
29826	Waldfrucht Torte 26 cm 5403	1250 g
29883	Tiramisu-Riegel 8 Stk	750 g





## Plattenkuchen

29555	Apfel-Mandel 0505	2250 g
29686	Apfel-Butterstreusel 0492	3300 g
29078	Bienenstich-Mandel 4186	1250 g
29088	Brownies 5658	1000 g
29683	Creme-Steusel Schnitte 4788	2150 g
28771	Donauwelle 0496	2100 g
28931	Erdbeer-Buttermilch 3250	2000 g
29685	Erdbeer-Rhabarber 0510	2400 g
28932	Himbeer-Käsesahne 3268	2000 g
29718	Käse-Schnitte 0495	3100 g
29717	Kirsch-Rhabarber 0493	1800 g
29504	Latte-Macchiato 4782	1500 g
28933	Mandarinen-Käsesahne 3269	2000 g
29676	Marzipan-Amaretto 4783	1500 g
28972	Mohn-Butterstreusel 0506	2350 g
28944	Pannacotta-Orange 3247	1750 g
29581	Pfirsich-Melba-Joghurt 4784	1500 g
28616	Pflaumen- Butterstreusel 0494	2750 g
29675	Schoko-Kokos 4181	1500 g
29682	Schoko-Streusel Schnitte 4789	2150 g
29082	Schwarzwälder-Kirsch 3580	1500 g
28945	Zitronen-Limette 3249	1350 g
28686	Dia. Apfelschnitte 2930	2100 g
28735	Dia. Aprikose 2932	2100 g
28923	Dia. Erdbeer-Sahne 3461	1750 g
29684	Dia. Käse-Heidelbeer 5141	2500 g
28736	Dia. Mandarinen-Kirsch 3267	1850 g
28677	Dia. Pflaumenschnitte 2931	2100 g



## TK-Gebäck, fertig gebacken

21935	Apfelstrudel Langn. 100g	20 Stk
29630	Apfelstrudel 160g	36 Stk
33785	Croissants Konfitüre	50 Stk
29166	MGF Donuts natur 45g	96 Stk
29173	MGF Donuts Cocos	48 Stk
29176	MGF Donuts Schoko 56g	48 Stk
29147	MGF Donuts White 52g	72 Stk
29091	MGF Donuts Vanille 76g	48 Stk
29413	GC Donut Banane 58g	36 Stk
29492	GC Donut Party 58g	36 Stk
29400	GC Donut Erdbeer 58g	36 Stk
29771	Mini-Gugl Karamel	12 Stk
29772	Mini-Gugl Mandel-Kirsch	12 Stk
29773	Mini-Gugl Schoko Duo	12 Stk
29502	Mini-Gugl Stracciatella	12 Stk
29503	Mini-Gugl Vanilla	12 Stk
33382	Bruschetta 100g	8x4 Stk



40416 **Panini-Master**  
Grauguß-Platten 230 x 250 mm  
bis 300°C



40000 **Sandwich-Toaster**  
Ober- und Unterhitze separat  
Innen: 350 x 250 x 170

## Eisbecher

	Größe	Inhalt	Menge/Kt
32177	5 M hoch	90 ml	2500
32178	7 C hoch	110 ml	2500
32162	108 C flach	125 ml	2000
32181	9 C hoch	140 ml	2925
32182	10 MG flach	170 ml	1500
32183	71 G hoch	170 ml	1750
32184	16 G hoch	220 ml	1750
32185	M 2 flach	250 ml	960
32186	M 3 hoch	290 ml	960
32174	MD 4 flach	350 ml	1000
32187	M 4 hoch	500 ml	900
31057	M 500 hoch	550 ml	900
32188	M 6 hoch	580 ml	760
31042	M 75 hoch	750 ml	600
32180	M 8 flach	1000 ml	400
32176	1000S hoch	1150 ml	504



## Milchmixbecher

	Größe	Inhalt	Menge/Kt
32205	11C / T3	250 ml	2000
32172	42C / T1	300-350 ml	2000
32173	58C / T58	500 ml	1000
31969	Deckel für 11C		2000
31971	Deckel für 42C		2000
31973	Deckel für 58C		1000



## Kaffeebecher

		Menge/Pk
13873	Kaffeebecher 200 ml	75
13870	Kaffeebecher 250 ml	75
13869	Kaffeebecher 300 ml	50
13877	Deckel für 200 + 250 ml	100
13876	Deckel für 300 ml	100

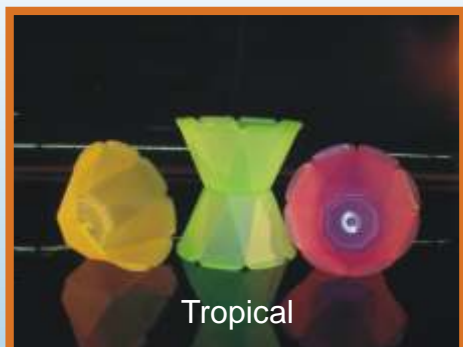

## Kunststoff-Becher

		Menge/Kt
32565	Klarsichtbecher 300 ml	900
32564	Klarsichtbecher 400 ml	450
32665	Klarsichtbecher 500 ml	450
31075	Ondulina 150 ml	1200
31923	Ondulina 250 ml	800
31921	Ondulina 350 ml	600
31076	Ondulina 450 ml	600
31077	Ondulina 550 ml	600
31201	Spavalda 100 ml	2500
31135	Spavalda 200 ml	1200
31136	Spavalda 300 ml	800
31078	Spavalda 400 ml	600
31079	Spavalda 500 ml	600
31072	Tropical 100 ml	1200
31137	Tropical 150 ml	900
31202	Tropical 200 ml	900
31203	Tropical 250 ml	900
31204	Tropical 350 ml	900
31205	Tropical 450 ml	900
31206	Tropical 550 ml	600
31213	Allegra 100 ml	1200
31212	Allegra 150 ml	1200
31211	Allegra 200 ml	960
31209	Allegra 300 ml	960
31210	Allegra 400 ml	600
31080	Bananenboot 21x12 cm	600

## Eislöffel

33834	Eisspaten Neon 9,5 cm	10 kg
32221	Kaffeelöffel Neon	2500 Stk
32218	Kaffeelöffel weiß	2000 Stk



## Trinkhalme

32216	Knickhalme ungehülst	1000 Stk
31744	Knickhalme gehülst	1000 Stk
48720	Knickhalme 6 mm Ø	100 Stk
48716	Knickhalme 7 mm Ø	250 Stk
48718	Knickhalme m. Löffel	250 Stk

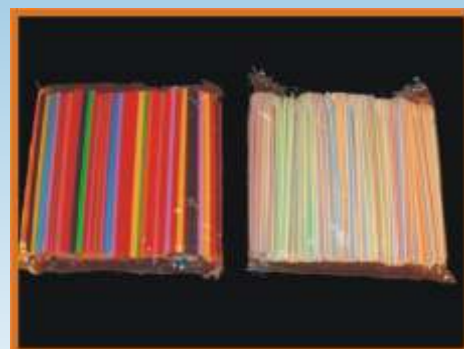

## Servietten

15016	Servietten Motiv Italia	5x2000
30382	Deckchen 17x17	4000
14066	Duni Prägeservietten 33x33	100
14025	Fuchs Prägeservietten 33x33	500



## Kunststoff-Schalen

30142	Pizzateller ca. 24 cm Ø	100
30151	Thermo-Sahneschalen 280 ml	100
30150	Thermo-Sahneschalen 400 ml	100
30149	Thermo-Sahneschalen 800 ml	100
30153	Hamburger Schalen 12x12 cm	500
31215	Styropor-Becher FC12 350 ml	500
31207	Styropor-Becher FC16 500 ml	500
30141	PVC Sahneschale 125 ml	250
30140	PVC Sahneschale 250 ml	250
30139	PVC Sahneschale 500 ml	250
30146	PVC Sahneschale oval	250







## Rollenpapier

33065	Eis Italia 30 cm	6 kg
33817	Eis Italia 50 cm	10 kg
30555	Flair 50 cm	10 kg
30027	Heiß auf Eis 50 cm	10 kg
31041	Pelle Aglio blau 50 cm	17 kg
30140	Pelle Aglio rot 50 cm	17 kg
30009	Zellstoff weiß 30 cm	6 kg
30008	Zellstoff weiß 50 cm	10 kg



## Pappteller

30182	Pappteller 9 x 15	250 Stk
30184	Pappteller 10 x 16	250 Stk
30186	Pappteller 11 x 17	250 Stk
30188	Pappteller 13 x 20	250 Stk
30190	Pappteller 16 x 20	250 Stk
30192	Pappteller 16 x 23	250 Stk
30202	Pappteller 18 x 26	250 Stk
30208	Pappteller 18 x 34	250 Stk
30199	Pappteller 21 x 29	250 Stk
30205	Pappteller 24 x 34	250 Stk

## Mokkadeckchen

30336	Mokkadeckchen 13x18 cm	500 Stk
30337	Mokkadeckchen 15x22 cm	100 Stk
30400	Mokkadeckchen 17x24 cm	500 Stk
30332	Mokkadeckchen 18x26 cm	500 Stk

## Sahneabdeck-Papier

30014	Pergamin 18 x 24	1000 Stk
30013	Pergamin 24 x 32	1000 Stk
30030	Zellglas 18 x 24	5 kg
30031	Zellglas 24 x 36	5 kg

Il miglior vetro...



...per il miglior gelato

## Gläser

48924	Glasteller Fantasy 501	6 Stk
48973	Eisschale Gondola 129	12 Stk
48946	Eisglas Bibita 1001	6 Stk
48948	Eisglas Tirreno 1003	6 Stk
48947	Eisglas Coppa Lido 1009	6 Stk
48908	Eisglas Pacifico 1010	6 Stk
48977	Eisglas Cali. Ligure 1012	6 Stk
48995	Eisglas Baltico 1022	6 Stk
48967	Eisglas Cali. Ticino 1027	6 Stk
48683	Eisglas Savonna 1028	6 Stk
48686	Eisgals Cali. Elba 1029	6 Stk
48994	Eisglas Egeo 1031	6 Stk
48936	Eisglas Navona 1228	6 Stk
48989	Eisglas Firenze 1300	6 Stk
48687	Eisglas Caraibi Blu 1817	6 Stk
48999	Eisglas Cali. Lucca 1823	6 Stk
48945	Eisglas Cali. Rigato 1824	6 Stk
48951	Eisglas Cali. Tulipano 1825	6 Stk
48993	Eisglas Coppa Ester 1828	6 Stk
48935	Eisglas Ischia 1858	12 Stk
48941	Eisglas Vulcano 1861	12 Stk
48688	Eisglas Amicizia 1866	4 Stk
48970	Eisglas Spirale 1868	6 Stk

# ADRIAGEL®



# ADRIAGEL®



# ADRIAGEL®

## Keramik

48933	Keramik Rennwagen 305	6 Stk
48949	Keramik Pizzateller 318	12 Stk
48932	Keramik Blume 324	12 Stk
48934	Keramik Teller Zurigo 333	12 Stk
48998	Keramik Banane 351	12 Stk
48975	Keramik Tavolazza 360	6 Stk
48984	Keramik Eistüte 379	6 Stk
48938	Keramik Bärchen 380	6 Stk
48927	Keramik Delfin 383	6 Stk
48974	Keramik Clown 386	6 Stk
48997	Keramik Biene 387	6 Stk
48979	Keramik Tiere 388	6 Stk
48976	Keramik Pinocchio 390	6 Stk
48685	Keramik Fußball 392	6 Stk
48926	Keramik Schale oval 412	12 Stk



48351 Eisspachtel 26 cm 021 1 Stk

## Eisbesteck

48401	Eislöffel	12,5 cm
48391	Kaffeelöffel	14 cm
48402	Mokkalöffel	18 cm
48394	Limolöffel	20 cm
48409	Limolöffel	22 cm



## Manuelle Reinigungsmittel

47728	Allzweckreiniger AR 250	10 ltr
47736	Glasreiniger UR 6	1 ltr
47725	Edelstahlpflege UR 7	1 ltr
47722	Toilettenreiniger UR 11	1 ltr
47748	Desinfektionsmittel Zoom 8	2 ltr
47723	Handreiniger m. Desinfektion	1 ltr
47713	Kaffeemaschinen-Reinig. 445	1 kg



## Reinigung für Spülmaschinen

47703	Pulverreiniger f. Cafegeschirr GS 100	10 kg
47705	Flüssigreiniger f. Cafegeschirr GS 300	12 ltr
47704	Flüssigreiniger f. Cafegeschirr GS 300	25 ltr
47706	Flüssigreiniger f. Eiscafe-Geschirr GS 330	6 ltr
47731	Flüssigreiniger f. Eiscafe-Geschirr GS 330	25 ltr
47724	Klarspüler GT 40	10 ltr
47726	Klarspüler GT 40	20 ltr
47712	Entkalker flüssig EK 2000	12 ltr
47729	Entkalker Pulver EK 3000	1,5 kg

## Usilin

47413	Usilin 2000 Desinfektionsreiniger	1 ltr
47415	Usilin 2000 Desinfektionsreiniger	10 ltr
47435	Usilin Speed Desinfektion	1 ltr
47534	Permano Handseife Dekontamination	1 ltr
47419	Hygiene-Handtuch	1 Stk

# USILIN®



## Wasser-Desinfektion

32220	Aqua-Clean	1 ltr
-------	------------	-------

Wasserdesinfektion  
"Aqua Clean"



Immer sicheres und frisches Trinkwasser

- konserviert Trink- und Brauchwasser zuverlässig
- schützt vor bakteriellen Infektionen in Trinkwasser
- ist geschmacks- und geruchsneutral

## Sonstige Reinigungsmittel

02442	P3 Steril flüssig	10,1 kg
02712	Ajax Allzweckreiniger Citro	10 ltr
02722	Ajax Allzweckreiniger Frühling	8x1 ltr
02630	Der General Allzweckreiniger	10 ltr
02833	Meister Propper Allzweckreiniger	10 ltr
02717	Palmolive Geschirrspülmittel	10 ltr
02605	Pril Geschirrspülmittel	10 ltr
02603	Pril Geschirrspülmittel 750 ml	14 Stk
02610	Pricol Ultra	4 kg
02617	Somat Spezialsalz	6 kg
02618	Topmat Pulver-Reiniger	10 kg



## Insektenvernichter

41351	Kenyatox Spray
40489	Copyr-Matic Spender



# haug® bürsten



## Haug

47020	0760 Fensterwischer
47051	0988 Straßenbesen hart 40 cm
47052	0990 Straßenbesen 40 cm
47018	1580 Spülbürste
47015	1950 Kehrgarnitur
47041	19500 Handbesen
47042	3150 Nagelbürste
47048	6010 Scheuerbürste
47047	6080 Stielscheuerbürste
47074	6840 WC-Garnitur
47091	7206 Nagelbürste "Anti Bac"
47021	8111 Spitztüllenbürste
47078	8114 Rohrbürste 300/15 mm
47146	8116 Gastro-Bürstenset
47065	8123 Rohrbürste 500/20 mm
47017	8124 Rohrbürste 500/40 mm
47062	8125 Rohrbürste 500/60 mm
47070	8620 Zellschwamm
47095	8630 Schrubber 60 cm
47081	86502 Besen fein 60 cm

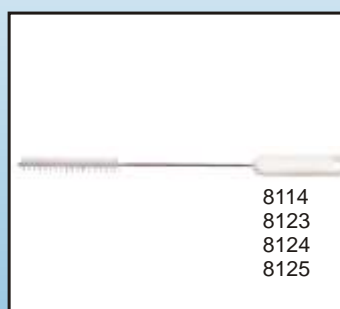

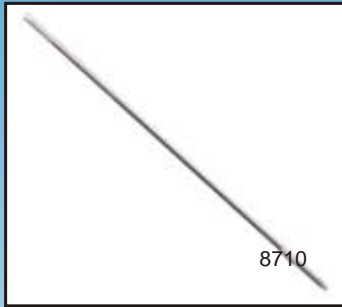

8710



8750  
8880



87512



8780  
8790



8820



8830



88602



8862



88822

**Haug**

47057	8660 Besen 60 cm
47054	8670 Arenga-Besen 60 cm
47025	8705 Besenstil Glasfaser
47008	8710 Besenstil Alu
47067	8750 Besen Haarmischung 28 cm
47002	87512 Besen Poly 28 cm
47709	8780 Wasserschieber 60 cm
47010	8790 Wasserschieber 40 cm
47022	8810 Schrubber Poly 28 cm
47004	8820 Stielbürste Poly 26 cm
47007	8830 Waschbürste Poly 19 cm
47164	8840 Großwischer 40 cm
47003	8550 Schrubber Poly 22 cm
47085	88602 Besen blau 40 cm
47028	8862 Arenga-Besen 40 cm
47077	8880 Besen Haarmischung 40 cm
47089	88822 Besen Poly blau 40 cm fein
47012	8885 Besen Poly blau 40 cm
47023	8890 Wischer Poly 40 cm
47026	8905 Gläserbürste



8905



8440



8447



1990



8793





**Eisportionierer**

48047	1/8 CR	1/8 blau	48113
48035	1/10 CR	1/10 blau	48104
48027	1/12 CR	1/12 blau	48105
48029	1/20 CR	1/20 blau	48106
48030	1/24 CR	1/24 blau	48107
48031	1/30 CR	1/30 blau	48108
48082	1/36 CR	1/36 blau	48118
48083	1/40 CR	1/40 blau	48119
48084	1/45 CR	1/45 blau	48120
48032	1/50 CR	1/50 blau	48121
48086	1/55 CR	1/55 blau	48127
48087	1/60 CR	1/60 blau	48122
48088	1/65 CR		



**Eistütensilos**

48129	4 x 26 mm Ø + 1 x 31 mm Ø
	8 x 26 mm Ø + 3 x 31 mm Ø
48156	9 x 26 mm Ø + 4 x 31 mm Ø
48155	12 x 26 mm Ø + 6 x 31 mm Ø
	16 x 26 mm Ø + 9 x 31 mm Ø

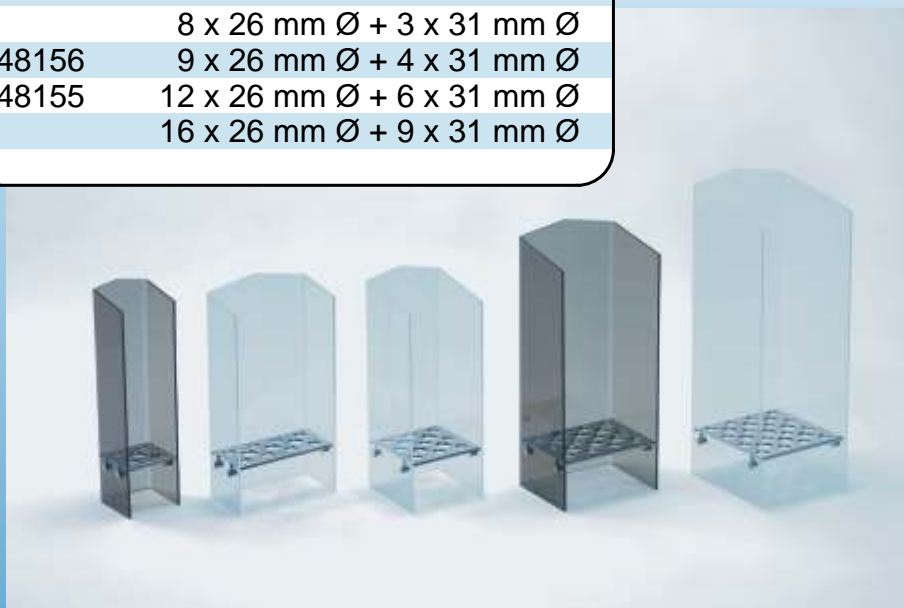

# stöckel®



Portinierer-Dusche 16



Einbauspüle 54



Serviettenspender 30

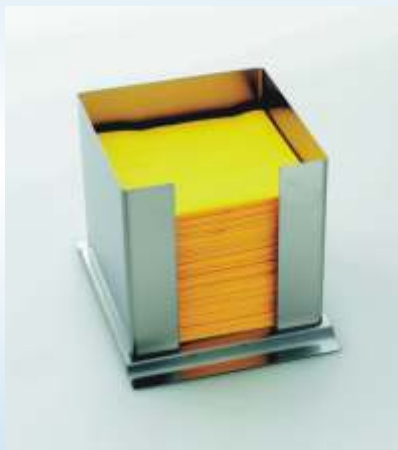

Serviettenbox 33



Menükartenhalter 410



Menükartenhalter 407



Eistütenhalter 303



Eistütenhalter 324



Kombi-Box 2er 632  
Kombi-Box 3er 633

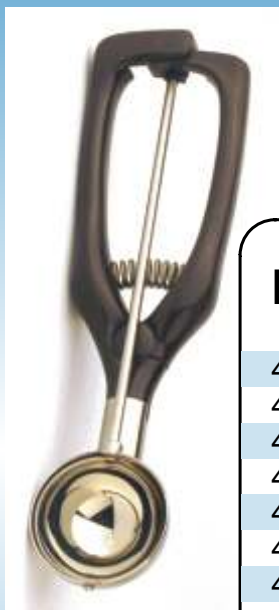

### Eisportionierer

48060	1/12 braun	1/12 blau	48157
48061	1/16 braun	1/16 blau	48167
48058	1/20 braun	1/20 blau	48158
48048	1/24 braun	1/24 blau	48159
48051	1/30 braun	1/30 blau	48160
48050	1/36 braun	1/36 blau	48160
48052	1/40 braun	1/40 blau	48162
48059	1/45 braun	1/45 blau	48163
48053	1/50 braun	1/50 blau	48164
48054	1/55 braun	1/55 blau	48164



### Hygiene-Artikel

14043	Spender Falthandtuch
47502	Spender Mini-Handtuchrolle IA
47501	Spender Handtuchrolle IA
47541	Spender Handtuchrollen AA
	IA = Innenabroller / AA = Außenabroller
47504	Dispenser Flüssigseife
14060	Falthandtücher grün 5000 Stk
47511	Mini-Handtuchrolle IA 120 m
47515	Handtuchrolle IA 300 m
47542	Handtuchrollen AA
14053	Toilettenpapier 3-lagig
14062	Toilettenpapier 2-lagig
47503	Jumbo-Toilettenpapier 380 m
14003	Küchenrollen
47509	Mevon Desinfektionsseife





### Schüsseln Kunststoff

41559	Schüssel	4,5 ltr	28 cm
41558	Schüssel	6 ltr	32 cm
41557	Schüssel	9 ltr	36 cm
41550	Schüssel	13 ltr	40 cm

### Schütteimer Kunststoff

41598	Schütteimer	7 ltr
41592	Schütteimer	10 ltr



### Messbecher Kunststoff

41609	Messbecher	0,5 ltr
41610	Messbecher	1 ltr
41611	Messbecher	2 ltr
41612	Messbecher	3 ltr
41613	Messbecher	5 ltr



### Tonnen

41586	Rundtonne	50 ltr
41532	Rundtonne	75 ltr
41520	Rundtonne	100 ltr
41641	Fahrgestell für Rundtonne	
41680	Rollbehälter mit Deckel	





### Eisschalen Edelstahl

48563	210 x 200 x 170 mm
48565	210 x 200 x 200 mm
48552	330 x 160 x 120 mm
48564	330 x 165 x 180 mm
48566	330 x 250 x 80 mm
48567	330 x 250 x 120 mm
48569	330 x 250 x 180 mm
48553	360 x 165 x 120 mm
48554	360 x 165 x 150 mm
48555	360 x 165 x 180 mm
48556	360 x 250 x 150 mm
48558	360 x 250 x 180 mm

### Schüsseln Edelstahl

41549	Schüssel	16 cm
41548	Schüssel	22 cm
41545	Schüssel	24 cm
41543	Schüssel	30 cm
41542	Schüssel	38 cm



### Schütteimer Edelstahl

41598	Schütteimer	7 ltr
41592	Schütteimer	10 ltr
48570	Schütteimer	15 ltr

## Schneebeesen

42236	Schneebeesen	32 cm
42238	Schneebeesen	35 cm
42241	Schneebeesen	38 cm
42229	Schneebeesen	42 cm
42243	Schneebeesen	50 cm



## Schaber

42140	Stielschaber	klein
42041	Stielschaber	27 cm
42074	Stielschaber	33 cm
41079	Stielschaber	45 cm
43464	Rührlöffel	40 cm

## Schaufeln Alu

42167	Alu-Schaufel	160 mm
42166	Alu-Schaufel	210 mm
42165	Alu-Schaufel	265 mm
42164	Alu-Schaufel	310 mm
42163	Alu-Schaufel	350 mm
42162	Alu-Schaufel	400 mm
42161	Alu-Schaufel	430 mm



## Schaufeln Kunststoff

42182	Plastik-Schaufel	25 ml
42178	Plastik-Schaufel	50 ml
42173	Plastik-Schaufel	100 ml
42172	Plastik-Schaufel	250 ml
42177	Plastik-Schaufel	500 ml
42170	Plastik-Schaufel	1000 ml



**40079 Hängeschrank Edelstahl**  
 1000 x 400 x 650 mm  
 1200 x 400 x 650 mm  
 1400 x 400 x 650 mm  
 1600 x 400 x 650 mm  
 1800 x 400 x 650 mm  
 2000 x 400 x 650 mm



**40017 Arbeitstisch Edelstahl**  
 1000 x 600 x 850 mm  
 1200 x 600 x 850 mm  
 1400 x 600 x 850 mm  
 1600 x 600 x 850 mm  
 1800 x 600 x 850 mm  
 2000 x 600 x 850 mm



**40031 Regal Aluminium**  
 1025 x 500 x 1830 mm  
 1225 x 500 x 1830 mm  
 1525 x 500 x 1830 mm



**40021 Spültisch CNS**  
 1200 x 600 x 850 mm  
 1200 x 700 x 850 mm

## Neumärker

40325 **Waffeleisen**  
310x340x250 mm  
610x340x250 mm

40736 **Crêpes-Eisen**  
585x480x220 mm  
930x480x220 mm

**Schokowärmer**  
260 mm Ø, 470 mm H

**Granita-Spender**  
1 x 10 ltr 180x560x770 mm  
2 x 10 ltr 360x560x770 mm

**Getränke-Spender**  
1 x 7 ltr 250x260x570 mm  
2 x 6 ltr 250x260x680 mm  
3 x 6 ltr 400x260x710 mm





# SANOMAT

## Sanomat

40455	Euro-Piccolo 1,5 ltr	225x340x445 mm
40443	Euro-Piccolo 2,5 ltr	225x340x445 mm
40454	Euro-Favorit 1,5 ltr	225x340x445 mm
40491	Euro-Cream Hand 5 ltr	300x440x485 mm
40480	Euro-Cream Auto 5 ltr	300x440x485 mm
40010	Euro-Due 2 x 5 ltr	460x376x510 mm
47416	Sano-Super	1 ltr
47421	Sano-Desinfekt	1 ltr
47422	Sano-Desinfekt plus	1 ltr



# Spitzenqualität Made in Germany

# Mussana SAHNE-AUTOMATEN

Mussana		
40594	Pony	2 ltr
40445	Boy	4 ltr
40010	Lady	6 ltr
40010	Grande	12 ltr
47425	Mikroclean	

- Intensivkühlung bis in die Garniertülle
- Reinigungs-Automatik mit Intervallspülung
- 4-fach Portionierungseinrichtung, einstellbar
- Doppeltes Aufschlagsystem aus Edelstahl für perfekte Sahne
- Geringster Stromverbrauch
- 2 Jahre Garantie

Für weitere Details wenden Sie sich bitte an Ihren Fachberater.

### Der „Klassiker“ mit doppeltem Füllvolumen



#### 4-LITER-BOY

Breite 270 mm  
Höhe 440 mm  
Tiefe 470 mm  
Gewicht 36 kg  
Anschluß 230 V/50 Hz



#### 2-LITER-PONY

Breite 230 mm  
Höhe 440 mm  
Tiefe 390 mm  
Gewicht 33 kg  
Anschluß 230 V/50 Hz

### Der „Große“ mit schmaler Bauform



#### 6-LITER-LADY

Breite 270 mm  
Höhe 510 mm  
Tiefe 470 mm  
Gewicht 39 kg  
Anschluß 230 V/50 Hz

### Perfekte Hygiene:

#### MUSSANA - Mikroclean Desinfektionsreiniger

Gebinde:  
4 x 1 Ltr.



Gebinde:  
12 x 1 Ltr.

### Der „Volumenmeister“ mit kleiner Stellfläche

#### 12-LITER-GRANDE

Breite 390 mm  
Höhe 510 mm  
Tiefe 370 mm  
Gewicht 45 kg  
Anschluß 230 V/50 Hz



# Mussana

Kompetenz in Schlagsahne.

**- Fahnen sind unübersehbar -**

Der Wind im Freien sorgt für eine bewegte, sondern häufig sogar bewegende Werbung. Die Fahnen sind im Digitaldruckverfahren auf uv- und wetterbeständigen Material, vor- und rückseitig bedruckt. Als absolute Neuheit bieten wir Ihnen als Zubehör einen Spezial-Fahnenhalter mit Vakuumsaugfuß an. Der Fahnenhalter ist zur Befestigung auf allen glatten Flächen ( Glas usw... ) geeignet.



**EIS-Fahne "Digitaldruck"**

Format: 46x63cm  
 Druck: digital, Vorder- und Rückseite uv- und wetterbeständig  
 Material: Blockout PVC-Plane weiß, 700g m<sup>2</sup>  
 Verarbeitung: oben Hohlraum, unten und seitlich geschnitten#

Menge:  "Eis"

Menge:  "Softeis"

**Fahnenhalter "Spezial"**

Fahnenhalter zur Befestigung auf glatten Flächen ( Glas usw.. )  
 Vakuum-Saugfuß aus Gummi mit Kipphebel für starken Halt  
 100mm Ø  
 Fahnenstangenhalter Metall, verzinkt, 19mm Ø  
 Art.Nr.: 88466330

Menge:



**Vakuum-Saugfuß aus Gummi mit Kipphebel für starken Halt**

**Individueller Druck - ohne Aufpreis ! - Bereits ab 5 Stück**

**Fahnenhalterung "Standard"**

Selbstklebend und zum Anschrauben  
 Weiß, Kunststoff wetterfest  
 19mm Ø, ohne Abbildung  
 Art.Nr.: 88466325

Menge:

**Fahnenstange**

70cm, 18mm Ø, Farbe weiß  
 Kunststoff wetterfest, inkl. Endkappe und Gegenhalterung  
 Art.Nr.: 88466320

Menge:

**Preisschild-Halterung für Eisbehälter**

für alle gängigen Eisbehälter  
 60 mm hoch  
 kommt mit dem Eis nicht in Kontakt  
 Verpackungseinheit: 10 Stück  
 Art.Nr.: 248562  
 Preis/VPE:

Menge:

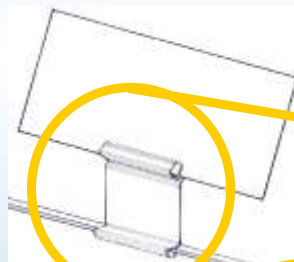

**Leuchtkreidemarker**

( mit Wasser oder "Bäcker-Blitz"-Reiniger abwischbar )

Zum Beschriften von Schreiftafeln, Tafelfolien, Folienschildern, Glas und Spiegel.

Schriftstärke 8+15mm		Schriftstärke 2+5mm	
Farbe:	Art.Nr.:	Farbe:	Art.Nr.:
orange	5901504	orange	5900504
schwarz	5901505	schwarz	5900505
pink	5901511	pink	5900511
blau	5901521	blau	5900521
weiß	5901508	weiß	5900508
grün	5901514	grün	5900514
rot	5901518	rot	5900518
gelb	5901515	gelb	5900515
Preis / Stück:	5,49 €	Preis / Stück:	3,49 €

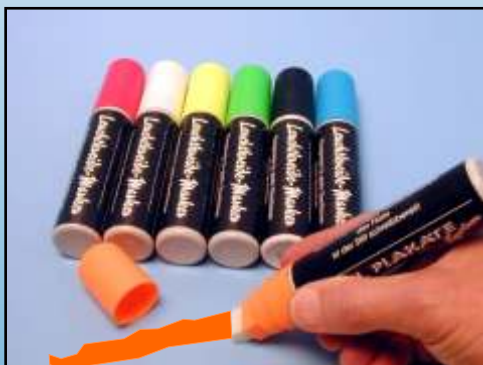

**Star 700**

- praktisch und stabil
- **vollverzinkt, Pulverbeschichtung**
- innenliegende Sicherheitscharniere
- sekundenschnelles Auswechseln der Plakate durch Magnetschutzfolien ( Antireflex, PET, UV-stabil )

- für Plakate DIN A1 ( 60 x 84 cm )

Art.Nr. 7000106 (blau)  
 Art.Nr. 7000108 (weiß)  
 Art.Nr. 7000115 (gelb)  
 Art.Nr. 7000118 (rot)

Höhe: 123 cm  
 Breite: 66 cm  
 Gewicht: ca. 22 Kg

**189,00 €**

**Unser Meistverkaufter !  
 10.000 zufriedene Kunden  
 können nicht irren !**

**Extrem standfest und haltbar !**



**VOLLVERZINKT !**

# NOSCH®



**Frappé-Mixer Edelstahl**  
zwei Rührwerke  
15000 U/min 300 Watt  
220x450x200 mm 3 kg



**Eispresse**  
mit 4 verschiedenen Einsätzen  
390x545x180 mm 2,5 kg



**Dynamic Mixer MX91**  
Stablänge 41 cm  
460 Watt



**Blender 0,9 ltr**  
Becher Polycarbonat  
28000 U/min 600 Watt  
200x410x200 mm 3,7 kg



**Eisflaker**  
zum Zerkleinern von Eiswürfeln  
120 kg Eis / Stunde 150 Watt  
230x460x210 mm 4,2 kg

# LIEBHERR

## FKS 5000

Kühlgerät mit statischer Kühlung  
Edelstahl weiß  
+2°C - +10°C  
752 x 710 x 1516 mm  
Nutzinhalt 433 ltr  
0,9 kWh / 24 Stunden



## GG 4360

Gefriergerät mit statischer Kühlung  
Edelstahl  
-9°C - -26°C  
600 x 655 x 1860 mm  
Nutzinhalt 407 ltr  
2,9 kWh / 24 Stunden  
Abtauverfahren manuell  
Temperaturanzeige außen digital



## GG 5210

Gefriergerät mit statischer Kühlung  
Edelstahl ggf. weiß  
-14°C - -28°C  
750 x 760 x 1864 mm  
Nutzinhalt 472 ltr  
1,2 kWh / 24 Stunden  
Abtauverfahren manuell  
Temperaturanzeige außen digital

# LIEBHERR

## GKpv 6570 ProfiLine

Kühlgerät mit Umluftkühlung  
 Chrom-Nickel-Stahl  
 +1°C - +15°C  
 700 x 830 x 2150 mm  
 Bruttoinhalt 601 ltr  
 1,2 kWh / 24 Stunden  
 Abtauverfahren automatisch  
 Temperaturanzeige außen digital



## GKv 5760

Kühlgerät mit Umluftkühlung  
 Edelstahl  
 +1°C - +15°C  
 750 x 750 x 1864 mm  
 Nutzinhalt 569 ltr  
 1,2 kWh / 24 Stunden  
 Abtauverfahren automatisch  
 Temperaturanzeige außen digital

## GTL 6105

Gefriertruhe  
 Stahl weiß  
 -14°C - -26°C  
 1647 x 776 x 917 mm  
 Nutzinhalt 572 ltr  
 1,5 kWh / 24 Stunden  
 Abtauverfahren manuell  
 Temperaturanzeige außen analog



**STETTNER****Carrettino**

Speiseeiswagen  
steckerfertig, Umluftkühlung  
temperierter Glasaufbau  
mit Beleuchtung, autom. Abtauung  
Portionierspüle mit Wasserhahn  
Anschluss für Sahnemaschine  
2000 x 1285 x 2081 mm  
10 Eisschalen à 4,75 ltr  
12 Eisschalen à 5 ltr  
-14°C - -16 °C bei 30°C UT  
10,6 kWh / 24 Stunden

**Schockfroster SF15-CW**

mit elektron. Kerntemperaturfühler  
bis zu 3 Behälter Gastronorm 1/1  
außen 760 x 760 x 970  
innen und außen CN-Stahl  
Bruttoinhalt 115 ltr  
15 kg / 24 Std. schockfrostet  
Abkühlbereich: +90°C - -18°C  
Konservierungstemp.: -18°C  
5,9 kWh / 24 Stunden

**Eiscreme Lagerschrank LABOR**

stille Kühlung, Lüfter für Kühlung separat  
außen 670 x 925 x 2050 mm  
innen und außen CN-Stahl  
Bruttoinhalt 668 ltr  
max. 66 Eisschalen à 5 ltr  
max. 47 Eisschalen à 7 ltr  
bis -18°C  
7,7 kWh / 24 Stunden

**STETTNER**

**Panoramakühlvitrine CRISTAL**

Umluftkühlung  
 5 Glasböden höhenverstellbar  
 außen 620 x 666 x 1250 mm mit Rollen  
 Bruttoinhalt 350 ltr  
 +6°C - -2°C



**Eisvitrine SAMOA**

Umluftkühlung, gebogene Verglasung  
 helle Innenbeleuchtung, autom. Abtauerung  
 elektron. Steuerung mit Digitalanzeige  
 -16°C - -18°C

Samoa	4	7	9	12
außen breit	824	1354	1659	2119
außen tief	627	627	627	627
außen hoch	1247	1247	1247	1247
GN 4,75 ltr	4	7	9	12
GN5 ltr	4+4	7+7	9+9	12+12



**Eisvitrine FOCUS**

Umluftkühlung, gebogene Verglasung  
 Innenbeleuchtung, Nachttrollo  
 Digitalthermometer, autom. Abtauerung  
 -16°C - -18°C

Focus	12	16	18	20
außen breit	1100	1440	1600	1770
außen tief	1148	1148	1148	1148
außen hoch	1353	1353	1353	1353
GN 5 ltr	24	32	36	40



**Eisvitrine MILLENIUM**

Umluftkühlung, gebogene Verglasung  
 auch für schwierige klimatische Bedingungen  
 Digitalthermometer, Innenbeleuchtung  
 beleuchtete Eissortenschilder, Nachttrollo  
 -14°C - -16°C

Millenium	12	16	18	20	24
außen breit	1120	1480	1650	1820	2160
außen tief	1062	1062	1062	1062	1062
außen hoch	1392	1392	1392	1392	1392
GN 5 ltr	12	16	18	20	24







**Kontrollwaage JHK**

Wiegefläche 140 x 140 mm  
 Wiegebereich 4 kg  
 Zifferschritte 1 g  
 LCD-Anzeige  
 Tarafunktion, Stabilitätsanzeige  
 Batteriebetrieb, Netzteil möglich



**Zutatenwaage 30-01**

nicht eichfähig  
 Wiegefläche 337 x 248 mm  
 Wiegebereich 30 kg  
 Zifferschritte 1 g  
 LCD-Anzeige mit Hinterleuchtung  
 Rezeptur-, Hold- und Tarafunktion  
 Netz- und Akkubetrieb



**Zutatenwaage 7515**

nicht eichfähig  
 Wiegefläche 235 x 178 mm  
 Wiegebereich 15 kg  
 Zifferschritte 0,5 g bis 7,5 kg  
 ab 7,5 kg 1 g  
 LCD-Anzeige mit Hinterleuchtung  
 Tarafunktion  
 Netz- und Akkubetrieb



**Zutatenwaage TWW**

komplett Edelstahl  
 Wiegefläche 220 x 185 mm  
 Wiegebereich 15 kg bei 1 g  
 oder 30 kg bei 2 g  
 tauchwassergeschützt  
 LED-Anzeige rot leuchtend  
 Tarafunktion  
 Netz- und Akkubetrieb



**Stativwaage DEF**

Lastplatte Edelstahl  
 Wiegefläche 305 x 355 mm  
 Wiegebereich 30 kg bei 5 g  
 oder 60 kg bei 10 g  
 Höhe Stativ ca. 50 cm  
 LCD-Anzeige mit Hinterleuchtung  
 Netz- und Akkubetrieb





Registrierkassen • Computerkassen  
**Wentingmann**

Ihr zuverlässiger Partner

**Drensteinfurt**  
Telefon 0 25 08 - 99 400 88  
Telefax 0 25 08 - 99 400 89

**Hamm**  
Telefon 0 23 81 - 30 60 20

[www.kassen-wentingmann.de](http://www.kassen-wentingmann.de)



### Eiskarten

48524	Cocktail
48521	Crêpes
48526	Banane
48528	Eiskaffee
48525	Erdbeer
48532	Joghurt
48523	Spaghetti
48510	Schoko
48522	Snacks
48506	Waffeln



## Streudekor aus Zucker

46169	Alphabet	600 g
46472	Confetti klein	600 g
46492	Confetti groß	600 g
46271	Herzen rot	600 g
46272	Ostern	600 g
46125	Sterne Weiß-Gelb	600 g
46152	Tannenbäume	600 g
45454	Nonpareille	1000 g
47149	Schokolinsen Smarties	1000 g



## Einstecker

48910	Flexi-Halm Wabenfrüchte 24 cm	100 Stk
48796	Flaggen-Picker International	100 Stk
48824	Flaggen-Picker Italien	1000 Stk
48911	Herzen Chenille bunt	100 Stk
48920	Herz mit Palme 21 cm	50 Stk
30403	Schirmchen	144 Stk
48912	Vulkan	100 Stk





Nizza Teak



Nizza



Nizza Alu



Jenny



Betty



Mary



Siena



MODELL	Speiseeis								Frucht- creme	Granita optional	Geschn. Rühr- werkam. Anzahl	Elektrischer Anschluß*			Installierte Stromleist.	Konden- sator**	Abmessungen cm			Netto- Gewicht Kg			
	Menge pro Gefrierzyklus				Stundenleistung							Menge pro Zyklus kg	Menge pro Zyklus kg	Volt			Hz	Ph	kW		am Boden		Höhe
	eingef. Mix kg		prod. Eis Liter		eingef. Mix kg		prod. Eis Liter														Breite	Tiefe	
	min.	max.	min.	max.	min.	max.	min.	max.															
Labotronic 10 30 RTX	1,5	5	2	7	10	30	12	42	4	4	2	400	50	3	3,2	Wasser	50	65	140	230			
Labotronic 15 45 RTX	2,5	7,5	3,5	10,5	15	45	21	63	6,5	6,5	2	400	50	3	5,2	Wasser	50	65	140	270			
Labotronic 20 60 RTX	3	10,5	4	15	20	60	28	90	9	-	2	400	50	3	6	Wasser	60	85	140	370			
Labotronic 30 100 RTX	5	16,5	7	23	30	100	42	138	12	-	2	400	50	3	9	Wasser	60	85	140	415			



